



2022
PROFESSIONAL



Mg HOTEL SUPPLIES

21, Markarian Building, Street 401, Mkalles
T: +961 1 694 194 M: +961 76 444 660
P.O.Box 55240 Sin El Fil, Lebanon
E-mail sales@mghotelsupplies.com
f MG SUPPLIES @ MG.SUPPLIES

GLOW

Dear customers, dear friends,,

two difficult years lie behind us. Hotel and restaurant lockdowns around the world have not made everyday business easy for any of us.

But we believe that the situation will ease worldwide in 2022 and that people will enjoy travel, culinary delights and company again.

So we look into the future positively and I am pleased, after a one-year break, to present to you the new Zieher main catalogue 2022.

We were using the calm times last year for new developments and present proudly – among others – our new buffet system “Glow”.

With “Glow” you can stage your products as a radiant centrepiece. But you will also find proven design and quality products in the catalogue, valued by top restaurants and hotels from all over the world.

We hope you enjoy browsing and look forward to a joint successful new year.

Yours sincerely



Dominik Zieher

All information about Zieher and the complete product range is available at WWW.ZIEHER.COM.



page 5



page 147



page 181



page 210



page 233

Buffet

- buffet displays “Glow”
- buffet displays “Textura” – “Somnia” – “Crossline”
- buffet systems “Skyline” – “Squareline” – “Curve”
- The Zieher-System “Konkret!” – “Neo” – “V12” – “Classy” – “Luxor” – “Solid” – “StiXXX” – “Basic” – “Antique”
- cooling element “Chiller-Base”
- “Lightning Buffet”
- buffet platters made of natural stone, laminated plastic and glass, buffet steps made of glass
- buffet stands “Stablo” and “Falcon”
- buffet bowls made of pewter, brass, shell, glass and stainless steel
- buffet etageres made of stainless steel
- “Fingerfood-Tree”
- serving trays and buffet systems made of walnut: “Mercato” – “Solid”
- buffet bridges and trays “Podia”

5

Catering

- Bento Box
- melamine trays and accessories
- serving trays and cutlery boxes
- tray system “Modul”: walnut – melamine – glass and china inserts

127

China, glass and more

- main series and small series made of china/glass
- china plates, platters, bowls and small bowls
- glass plates, platters, bowls and small bowls
- napkin rings made of pewter
- charger plates
- chloches made of glass

147

Wine glasses, decanter, bar and more

- wine glass series VISION and “Tesoro”, an aid to wine enjoyment
- wine decanter “Doppio”
- wine decanter/carafe “Star” – “Star” mini
- wine decanter “Eddy” – “Eddy” mini, “Pebble”
- basic ring with LED for decanter “Star” and “Eddy”
- champagne cooler “Stablo” and champagne flute “Vaganza”
- “The Bar Collection”

181

Miniatures

- anti-slip coasters made of silicone
- glass miniatures, borosilicate glass, double-walled glass
- china miniatures
- stainless steel miniatures
- skewers and natural stone

210

Cruet stands, trays, etageres, and more

- Bento Box made of melamine
- trays made of melamine and wood
- chocolate/truffles boxes, suitable inserts made of solid surface material
- bread baskets/boxes, trays and snack boards made of walnut
- etageres made of stainless steel
- jam trays and food displays
- cruet stands and trays with suitable inserts
- wind lights and accessories

232

Room service, guest rooms

- roomservice trays and accessories
- storage/presentation boxes, cutlery box “Solid”
- shelves and etageres
- displays and trays “Podia”

275

List of items in ascending order Table of content

285

290

Excellence since 1986 - Exclusive design since 2006

In the year 2006 we designed the first items ourselves and placed them on the market.
Since that time developing and implementing exclusive design objects has been our calling.
On this page we show a couple of the most important creations of the past years.

Design, innovation and quality are our mission!

The Zieher Design History



The timeline features a central map of Europe and a horizontal axis with years from 2006 to 2020. Key design objects are shown in boxes connected to the timeline:

- 2006:** A tall, slender wooden serving rack.
- 2009:** A white ceramic bowl with a spoon, containing a colorful salad.
- 2010:** A wooden serving tray with compartments for bread and small appetizers.
- 2011:** A glass bowl with a spoon, containing a dessert with fruit and cream.
- 2013:** The ZIEHER logo.
- 2014:** A set of three lit candles in tall, thin holders.
- 2015:** A large, shallow metal bowl on a stand, containing ice, champagne, and appetizers.
- 2017:** A large, tiered black serving stand with multiple levels for food.
- 2018:** A set of small, round appetizers on a white tray.
- 2019:** A set of three small cakes on black plates.
- 2020:** A set of wine glasses, including a decanter and several glasses filled with wine.

WWW.ZIEHER.COM
PHOTOGRAPHY: www.die-lichtzeichner.de

"Sombre", page 148



Table-Trees, page 248/249

Buffet



"Reef", page 73



"The Bar Collection", page 203-209



NEWS 2021/22!



"Tesoro", page 188



"Doppio", page 192



"Neo", page 32



"Glow" - reframing the buffet!

Filigree displays and frames with integrated lighting form the basis of the "Glow" system.

The matt black coating of these slim but still extremely sturdy lighting objects remains discreetly in the background and leaves the presentation of dishes to the warm and glare-free light.

"Glow" is a flexible system that creates unmatched buffet stagings. The filigree construction not only allows food and beverages to be presented on the displays, their inner side also creates enough space to effectively present delicacies in the right light.

All elements can be used lying or upright and create presentation levels at different heights - the basis for varied

and appealing buffet arrangements. Two connecting boards made of bent sheet metal can be attached as desired and thus enable the flexible construction of several elements - even across corners. Matching buffet platters made of glass or laminated plastic, as well as trays made of melamine, complete the system.

Zieher buffet systems have been inspiring with innovative lighting concepts for many years. In "Glow", this is now firmly integrated for the first time. The resulting subtle look of these lighting objects creates completely new facets of an atmospheric buffet ambience.

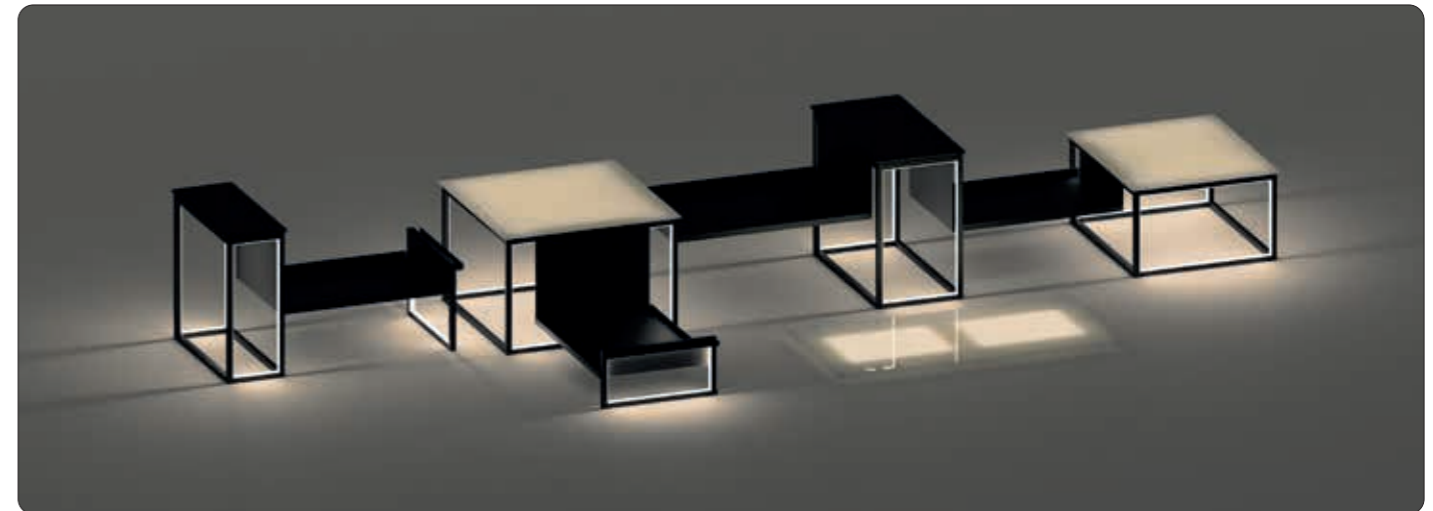

connecting board "Glow" L

steel, matt black (powder coating), usable on both sides, for placement between 2 LED displays (items 8400...) and -frames (items 8405...)

item	l x w x h in cm
8410.16	63.2x36.6x16.2



connecting board "Glow" M

steel, matt black (powder coating), usable on both sides, for placement between 2 LED displays (items 8400...) and -frames (items 8405...)

item	l x w x h in cm
8410.24	55.2x32.6x24.2



8400.24 + 8010.02

8400.16 + 8010.01



LED frame "Glow"

steel, matt black (powder coating), with circumferential LED stripe (warmwhite), incl. connection for power supply

item	l x w in cm	size
8405.16	32x16	S
8405.24	32x24	M



spacer/buffer

magnetic, black, rubberised, for non-slip and noiseless placement under buffet platters and trays on LED Displays GLOW (items 8400...)

item	Ø in cm	thickness in mm	PU
8414	1.7	4.4	4 pcs

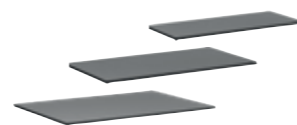

buffet platter, laminated plastic

laminated plastic, 8 mm thick, black, black intermediate ply, break-proof, scratch-proof, dishwasher-safe, antistatic, deburred edges, rounded corners

item	l x w in cm	for LED display
8010.01	41x17	S
8010.02	49x25	M
8010.03	49x33	L

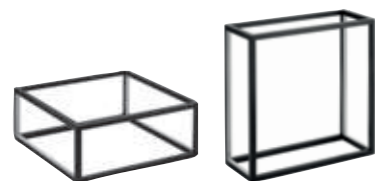

LED display "Glow" S

steel, matt black (powder coating), with 2 circumferential LED stripes (warmwhite), incl. 2 connections for power supply and -forwarding

item	l x w x h in cm
8400.16	40x40x16

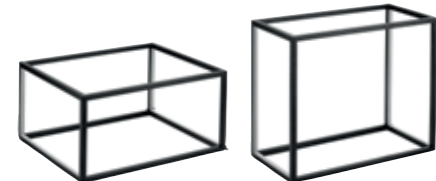

LED display "Glow" M

steel, matt black (powder coating), with 2 circumferential LED stripes (warmwhite), incl. 2 connections for power supply and -forwarding

item	l x w x h in cm
8400.24	48x40x24

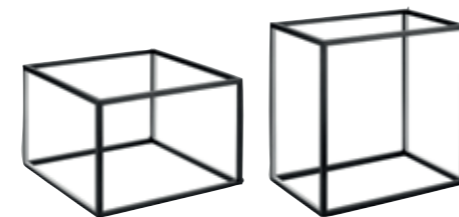

LED display "Glow" L

steel, matt black (powder coating), with 2 circumferential LED stripes (warmwhite), incl. 2 connections for power supply and -forwarding

item	l x w x h in cm
8400.32	48x48x32

Components of the system:

- The illuminated cuboids offer the possibility of operating up to three elements on one power supply, due to the two integrated connection sockets.
- Illuminated frames can be placed horizontally and thus enable the effective lighting of translucent buffet platters of all kinds. When set up, they fit into the height grid of the buffet cuboids and thus function as a space-saving support for attached connecting boards.
- The connecting boards are made of powder-coated sheet metal and allow a two-sided use. They can simply be hung between the cuboids and frames, creating additional presentation levels and areas.
- Precisely fitting glass platters of various types and platters made of black laminated plastic make it possible to quickly

and easily close the top of the illuminated cuboids. Various melamine trays from the range can also be used on some of the cubes. In the lying position, there is a large selection of suitable glass platters from the Zieher range available (50 x 50cm / 50 x 42cm / 42 x 42cm). These buffet platters are available on pages 50 to 57. If the cuboids are positioned upright, they can be covered with laminated plastic platters.

- Rubberised magnetic buffers ensure the non-slip and noiseless support of all platters and trays. These are available as accessories and can be placed anywhere on the displays and frames. Furthermore, they create the necessary distance in order to place glass or laminated plastic platters in spite of the attached connecting boards.



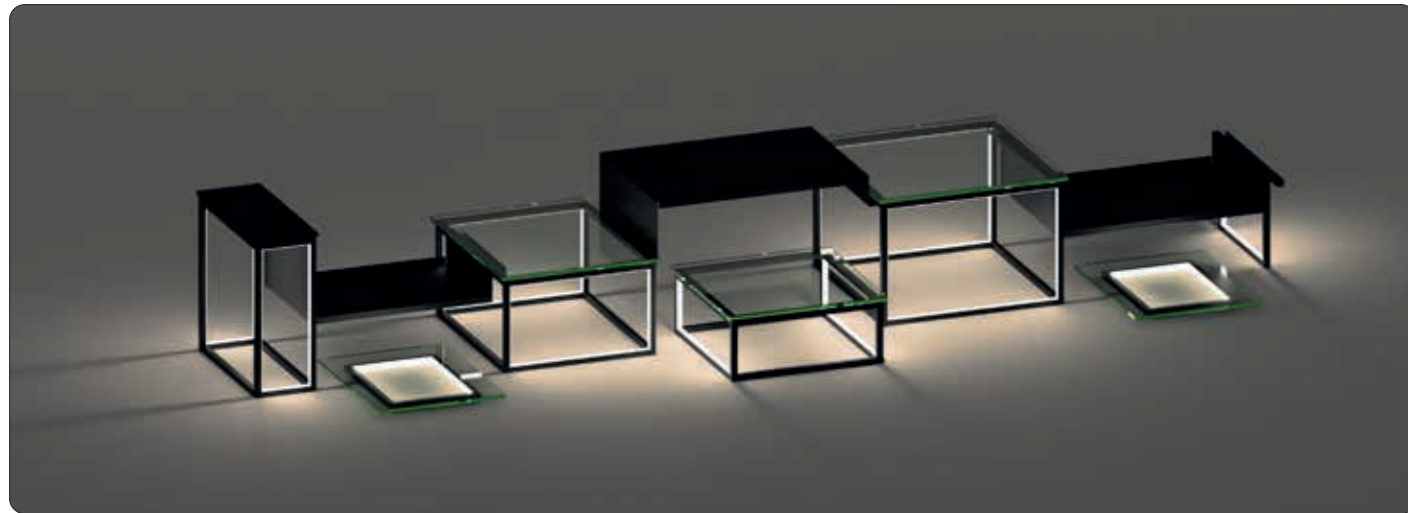

Accessories LED lighting:

- The power supplies are available with EU, US and UK plugs. The power of the supplies is sufficient to connect up to three cuboids or frames. Since each cuboid has two connection options, they can be strung together without any problems.
- As they only have one connection option, the two frames form the end of the chain. The energy-efficient LED lighting in warm white colour is operated with harmless 24 volts.
- Connecting cables with angled plugs are available in two lengths and help to keep the number of cables required as low as possible in numerous setups.
- Shapely and reusable cable holders made of durable silicone help to lay and fix power- and connecting cables inconspicuously or to bundle several cables.



connecting cable "Glow"
black, with angled plugs, for daisy chaining LED displays items 8400... and -frames items 8405...

item	length
8418.01	1 m
8418.02	2 m



power supply for LED displays and -frames "Glow"
black, 60W, 100-240V, for use with plug item 8416. EU/UK/US (please order separately), suitable for LED displays items 8400... and -frames items 8405...

item	length
8416	1.70 m



plug for power supply 8416
black, length 2 m, with integrated on/off switch

item	power plug
8416.EU	Europe
8416.UK	UK
8416.US	US

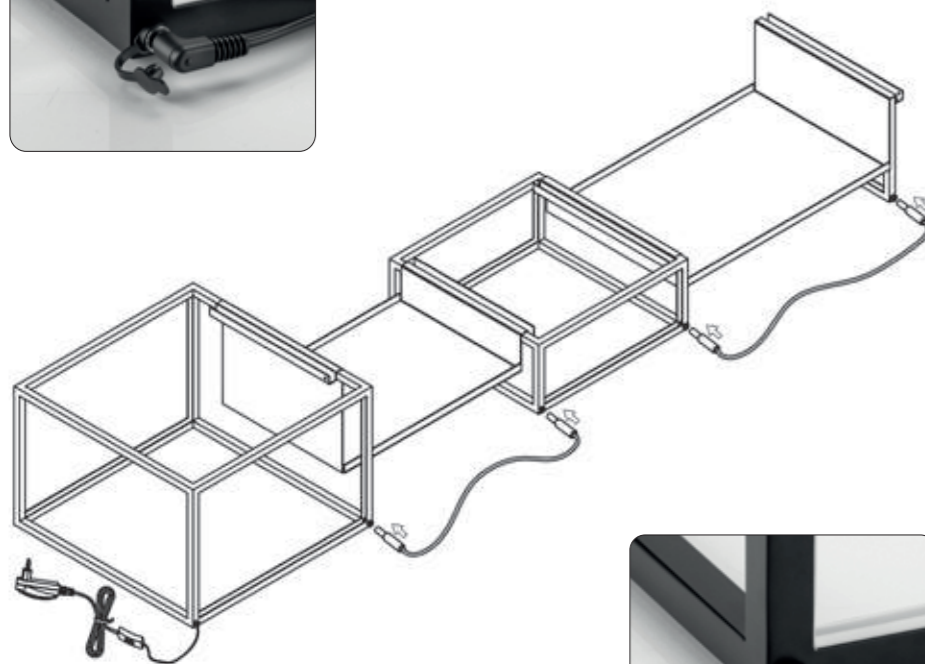

schematic illustration



Please note: 
This power supply is designed for the simultaneous use of a maximum of 3 LED displays or -frames from the "Glow" series!



cable holder
silicone, black, length 8 cm, with 3 fastening holes, reusable due to a detachable lock, suitable for guiding cables

item	PU
8412	10 pcs



base tray "Modul"
melamine, black, surface matt, food-safe, dishwasher-safe, not suitable for microwave and combi steam oven

item	l x w x h in cm	PU
4581	53x28x1.8	2 pcs

Please note: 
The melamine tray 4581 fits perfectly on the LED display M (item 8400.24) when set up.



More trays and boxes made of melamine are available from page 130 on.



The cloches and porcelain bowls and plates of the series “Cuspis” are available on page 152 and 176.

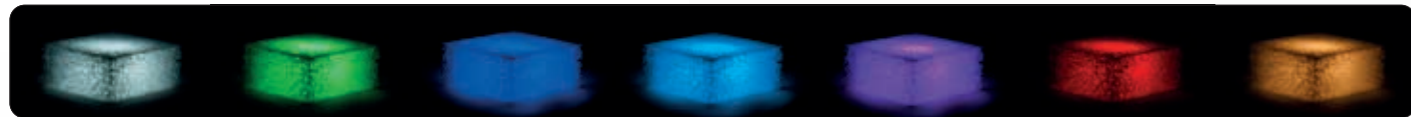

In order to grant a harmonic all-over illumination while using stacked cuboids, it is recommended to use one LED lamp per item. For usage of bigger buffet platters, we suggest to employ the elements with 30 cm edge length. Due to the flexible material, we recommend stacking a maximum of two cubes on top of each other, when the system is equipped with heavy platters or bowls.



precisely fitting recess for ZIEHER LED lights (page 48/49)



buffet display “Textura”

polyethylene, transparent, with notch for rechargeable LED-light item 8150

item	l x w x h in cm
8232.24	approx. 24x24x10.5
8232.30	approx. 30x30x10.5



“Textura” - indestructible, innovative, exclusive!

The exclusive cuboids of the “Textura” series are exceedingly interesting, even at a second glance, due to their awesome structure. They consist of thin polyethylene filaments, which are convoluted intricately and fused together. This awards them a flexible but nevertheless very stable texture. The true potential of this innovative material is only disclosed

in connection with light. The light-conducting properties of the filigree filaments manifest effectively when using the rechargeable Zieher LED light (page 48/49), which fits exactly into the cut-outs on the bottom side of the displays. The “Textura” buffet cuboids are available in two sizes which, when used separately or stacked on top of each



All information about the cooling elements “Chiller Base” can be found on pages 42 and 43

other, create different presentation levels on the buffet. Buffet platters and trays are reliably kept in position due to the non-slip features of this material. “Textura” lives up to the high demands of gastronomy and catering in numerous ways. The displays are indestructible and very light, washable and dirt-repellent. The countless interspaces create a light-flooded meshwork, which dries very quickly and is therefore resistant to humidity and mold. Also the raw material itself is something to be proud of. Polyethylene can repeatedly be 100% recycled without losing its outstanding characteristics. It is physiologically non-hazardous, odorless, tasteless and resistant to a variety of acids, oils and grease.

"Somnia"

"Somnia"

At first glance the golden branches, carefully strapped to a bundle, are reminiscent of a besom and braided objects of a different kind. The buffet displays and luminaires of the "Somnia" series are assembled from organically shaped, filigree rods which are made of solid brass in traditional sand casting. These single components, reminiscent of brittle branches, are afterwards melded in complex handicraft to impressive unique pieces. The matt-golden surface of the "Somnia" series harmonises elegantly with the grey glass of the handblown bowls, which have been specially adapted to the shape of the small stands. The two bigger buffet raisers form a precious basis for bowls and buffet platters of all kind. Optionally available black rubber caps can be fixed if required to improve the slip resistance and to protect the sensitive surface of furniture. The smallest version of these little pieces of art also impresses at a set table. An amuse-bouche, bedded on a nest of golden branches, will be treasured by the guests for a long time.



glass bowl
dark grey, round, handblown, ground edge

item	Ø in cm	height in cm	content in l
4814.17	17	5,5	approx. 0.3
4814.23	23	9,5	approx. 1.5
4814.30	30	13	approx. 3.25
4814.40	40	10	approx. 4.5

wind light
borosilicate glass, satined inside, open at the top and the bottom, for candle holder/wind light "Somnia" item 2383.01

item	Ø in cm	height in cm	PU
4991.02	9	14,5	6 pcs

The wind light of the "Somnia" series is equipped with a solid base plate with an elevated rim. This base avoids a leakage of wax and protects the table surface from heat. Furthermore, it forms the frame for a removable cylinder, made of heat resistant glass, which by way of its satined surface, intensifies the mood of light and protects the flame from wind at the same time. With candlelight, this extraordinary lighting object creates fascinating effects and provides for a cosy and comfortable ambience.



display for bowls "Somnia"
brass, golden, matt, not dishwasher-safe

item	Ø in cm	height in cm	for glass bowl
2385.01	approx. 15,5	approx. 13,5	4814.17
2385.02	approx. 23,5	approx. 22,5	4814.23

buffet display "Somnia"
brass, golden, matt, not dishwasher-safe

item	Ø in cm	height in cm
2386.10	approx. 21,5	approx. 10,5
2386.20	approx. 21,5	approx. 20,5

protecting cap
rubber, black, for buffet display "Somnia" items 2386...

item	Ø in cm	PU
4685	0,4	10 pcs

candle holder/wind light "Somnia"
brass, golden, matt, not dishwasher-safe, for glass insert item 4991.02 (please order separately) and candles up to Ø 7 cm

item	Ø stand in cm	Ø top in cm	height in cm
2383.01	11	approx. 16,5	approx. 19,5

The buffet platters “Industry 2.0” are available on page 53.



Buffet bowls in copper PVD coating are available on request.



More dark grey bowls are available on pages 78 to 83.

Industrial charme

The variant of raw steel with a rusted and sealed surface inspires by the charm of corroded metal and perfectly matches the industrial style of modern architecture! Low weight, space-saving storage due to its stackability, easy handling and quick installation are just a few advantages of the “Crossline” series. The neutral colouring of the stands can be combined harmoniously with many different materials. Thanks to the large variety of Zieher buffet platters, the arrangement of buffets can be redesigned again and again.



Hinged beams at the upper side of the trestle can be adjusted individually to the shape of bowls and platters.

buffet bowl

glass, 8 mm thick, dark grey, oval, structured, delivery in strong wooden box

item	l x w x h in cm
5176	130x42x8



For buffet bowl item 5704 (page 79) and platters of 42 cm x 42 cm and bigger.

buffet stand “Crossline” - rust

steel, rusted surface, transparent sealing, rectangular, hinged beams on top

item	l x w x h in cm	l x w in cm (on top)
8320.15R	41.5x41.5x15.5	34x34
8320.31R	49.5x49.5x31	34x34

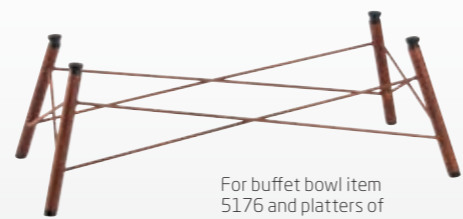

For buffet bowl item 5176 and platters of 80 cm x 40 cm and bigger.

buffet stand “Crossline” - rust

steel, rusted surface, transparent sealing, rectangular, hinged beams on top

item	l x w x h in cm	l x w in cm (on top)
8325.23R	70.5x33.5x23.5	59.5x22



For buffet bowl item 5704 (page 79) and platters of 42 cm x 42 cm and bigger.

buffet stand “Crossline”

galvanised steel, matt black (powder coating), square, hinged beams on top

item	l x w x h in cm	l x w in cm (on top)
8320.15	41.5x41.5x15.5	34x34
8320.31	49.5x49.5x31	34x34

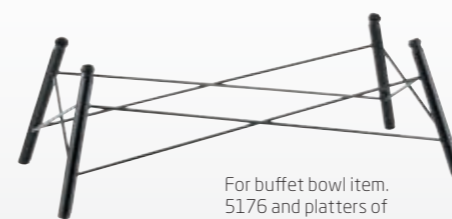

For buffet bowl item 5176 and platters of 80 cm x 40 cm and bigger.

buffet stand “Crossline”

galvanised steel, matt black (powder coating), rectangular, hinged beams on top

item	l x w x h in cm	l x w in cm (on top)
8325.23	70.5x33.5x23.5	59.5x22

Filigree understatement!

The filigree displays of the “Crossline” series feature an enormous stability due to their cleverly elaborated statics. These elements, which have been deliberately designed to have a plain and restrained appearance, unobtrusively blend into every ambience.

The rectangular base has been constructed especially for a presentation bowl made of dark grey glass, which impresses by its length of 130 cm. Hinged beams at the upper side of the trestle can be adjusted to the shape of the bowl individually. Hence also Zieher buffet platters of 80 cm x 40 cm and bigger can be installed. The supports are felt-covered, which minimises disturbing noise, evens out smaller asperities and provides for slip-resistance. Two more versions in square shape are constructed identically and are, for example, suitable for buffet platters in sizes 42 cm x 42 cm or 50 cm x 50 cm.

All trestles are made of galvanised steel and afterwards coated with a robust and scratch-proof powder-coating in a classy matt black. Therefore the stands are also suitable for outdoor areas.



The buffet bowl item 5704 is available on page 79.

"Skyline" – Manhattan-Feeling on the buffet

"Skyline" – the original!



"Skyline", Zieher's buffet system, allows a maximum of flexibility for the most exclusive buffet presentations. Different heights enable you to install big buffet platters on the one hand - on the other hand, they can be stabilised by insertion into the corresponding serration. The square columns are made of highly-polished stainless steel and due to the standardised serration heights, they can be combined with the "Squareline" (pages 24 to 26) and "Curve" series (page 27).

The spectacular look that brings the silhouette of skyscrapers to mind, is available in a highly-polished version and for an intensified effect, also in black and white colouring (gold and copper on request!). The optionally available Zieher LED-lights are a perfect addition to the system and come in 2 versions: cabled and rechargeable (pages 48 and 49). In combination with light-diffusing tubes (page 48), they provide a perfect illumination of the system in various colours.

The buffet platters are available on page 50.



"Skyline" – the original



Buffet platters made of glass, laminated plastic and slate are available from page 50 onwards.



buffet stand "Skyline"

massive stainless steel 18/10, matt black (powder-coated), square, not dishwasher-safe

item	l x w x h in cm
8300.10	25x25x10.5
8300.22	25x25x22.5
8300.34	25x25x34.5
8300.58	32x32x58.5

buffet stand "Skyline"

massive stainless steel 18/10, white (powder-coated), square, not dishwasher-safe

item	l x w x h in cm
8305.10	25x25x10.5
8305.22	25x25x22.5
8305.34	25x25x34.5
8305.58	32x32x58.5

buffet stand "Skyline"

massive stainless steel 18/10, highly polished, square, dishwasher-safe, food-safe

item	l x w x h in cm
2177.10	25x25x10.5
2177.22	25x25x22.5
2177.34	25x25x34.5
2177.58	32x32x58.5



The LED-lights, either as rechargeable or cable version, are available on pages 48 and 49.

silicone sleeve

transparent, slotted lengthwise, for buffet stand "Squareline" items 8081..., 8082..., 8084... and buffet stand "Skyline" items 2177..., 8300... and 8305... (prevents the slipping of buffet platters)

item	length in cm	PU
4684	2	10 pcs

acrylic glass tube

satined (white), removable lid for easy fitting of bowls etc., notch for cable for LED-light item 8104 (not included, please order separately)

item	Ø in cm	height in cm	PU
8122.10	12	10	3 tubes
8122.22	12	22	3 tubes
8122.34	12	34	3 tubes
8122.58	12	58	3 tubes



transport trolley

aluminium / plywood with ABS-coating, slate-grey, protected against dust and splashwater, lined with rigid foam, incl. stacking cams for safe stacking. 4 heavy duty swivel castors, 2 total brakes, loadable up to 100kg

item	l x w x h (inside) in cm	l x w x h (outside) in cm
5667.01	114x74.8x60	120x80x80
5667.02	74x55x54	78x59x66



Storage and transportation trolley

We are happy to offer you an individual solution for transportation and storage of your miscellaneous items. Please ask us!



Please note:



The displays of the series "Skyline" and many other items made of stainless steel can be refined to gold and copper versions.

All information about refining of stainless steel in PVD process on page 86.



"Skyline"



Please note: The bread baskets from the "Skyline" series have a closed base plate and rubber feet. They deviate in height from the buffet stands items 2177...

The bowl "Sixth Sense" is available on page 89.



fruit/bread basket "Skyline"
massive stainless steel 18/10, highly polished, square, with bottom plate and 4 rubber feet

item	l x w x h in cm
2179.10	25x25x11.5
2179.34	25x25x35.5



fruit/bread basket "Skyline"
massive stainless steel 18/10, highly polished, square, with bottom plate and 4 rubber feet

item	l x w x h in cm
2178.23	40x40x23.5

"Skyline" made by Zieher - Compare the original to copies of inferior quality!

"Skyline"

Reasons to stick with the original:

- Different versions: polished, matt black and white (golden and copper on request)
- Highest Zieher quality and perfect accuracy in manufacturing
- Compatibility with other Zieher systems
- 100 % fitting illumination
- Massive stainless steel 18/10
- Design by Zieher in 2009

Cabled and rechargeable, battery-powered LED-lights are available on pages 48 and 49.



The "Skyline" buffet system allows a maximum of flexibility for the most exclusive buffet presentations.

Due to the same serration heights, the "Skyline" system is combinable with our "Squareline" (pages 24 to 26) and "Curve" systems (page 27). The different adaptors of the "Squareline" system may equally be used with the "Skyline" stands (exception: columns with 58 cm height).

Some exemplary displays can be seen here:



"Skyline" black, connector pieces acrylic glass satined (page 26), acrylic glass tubes (page 48), rechargeable LED-lights (page 49).

"Skyline" highly polished, connector pieces acrylic glass black (page 26), platters black glass (page 54), acrylic glass tubes (page 48), rechargeable LED-lights (page 49).

"Squareline"



"Squareline" black, acrylic connector pieces satin (page 26), "Lightning Buffet" tubes (page 48), rechargeable LED-lights (page 49).

The rechargeable LED-light (item 8150, optionally available, page 49) offers numerous fixedly pre-installed colours, as well as special programs like colour gradient and flickering-candle-effect. The compatible remote control (item 8151) allows the synchronisation of up to 20 LED-lights at the same time and enables the change of the complete buffet-colouring by just pressing one button!

Alternatively and especially for fixed buffet installations, we recommend the use of the Zieher LED-lights with cable (item 8104, page 48).

With this item, 5 lighting colours can be set by using stick-on colour-filters.

The connector pieces feature slots, so that the cables can be laid invisibly through the columns of the "Lightning Buffet". To do this, the detachable lids of the acrylic tubes have to be removed. If cabled LED-lights are used, it is recommended to lay down all components of a "Squareline"- tower next to each other on the table to facilitate the installation of the cables.



"Squareline" black, acrylic connector pieces black (page 26), glass platters black (page 54), glass steps black (page 58).

Please note:



To illuminate the system, you will need one LED-light and one acrylic column in the fitting size (12 resp. 24 cm) for each "Squareline" stand. The acrylic columns are available in sets of 3 pieces (items 8120...) and can be found on page 48, the information on our LED-lights can be found on pages 48 and 49.



"Squareline" copper (on request), acrylic connector pieces satin (page 24), glass platters white (page 55), "Lightning Buffet" tubes (page 48), rechargeable LED-lights (page 49).



cabled LED-light, page 48

rechargeable LED-light, page 49

acrylic tubes, item 8120..., page 48

"Squareline" white, acrylic connector pieces black (page 26), glass platters black (page 54), glass steps black and glass trays black (page 58).

"Squareline"



The buffet system with 1000 faces!

Our classic "Skyline" has been changed and advanced to become "Squareline", which now offers several new features apart from its pure design.

The stainless steel displays are available in two heights. Three versions - highly polished, matt black and white (golden and copper on request), grant the columns completely different effects! The "Squareline" towers can be stacked on top of each other by using connector pieces, which are available in two different versions. A 90° rotated arrangement of the stands increases the creative leeway tremendously and permits a buffet set-up at an angle.

Besides the technical aspect, the connector pieces are mainly a decorative element.

They are available in glossy black or satin light-diffusing acrylic. In connection with the various versions of displays and buffet platters, countless possibilities for the creation of a buffet arise.

Optionally, "Squareline" offers the possibility of a 100% integration of our "Lightning Buffet" - the full height of the columns will be illuminated from the inside. When using the satin connector pieces, their light-diffusing effect even enhances the spectacular sight. The system is based on the buffet classic "Skyline" (pages 18 to 21), both in construction and in form. So both systems can be combined quite easily.

Just let your imagination run wild!



"Squareline" polished, acrylic connector pieces satin (page 26), platters transparent glass (page 56), buffet platter (page 56) and glass steps transparent (page 58), "Lightning Buffet" tubes (page 48), rechargeable LED-lights (page 49).

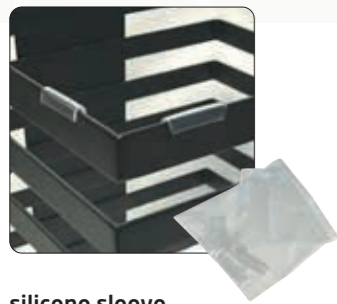

silicone sleeve
transparent, slotted lengthwise, for buffet stand "Squareline" items 8081..., 8082..., 8084... and buffet stand "Skyline" items 2177..., 8300... and 8305... (prevents the slipping of buffet platters)

item	length in cm	PU
4684	2	10 pcs

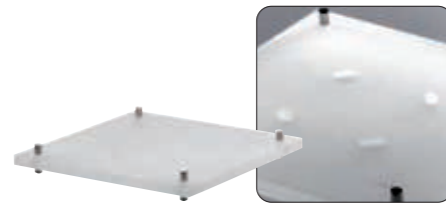

acrylic connector "Squareline"
clear satined (translucent), with 4 stainless steel pins and 4 holes for cable run

item	l x w x h in cm
8083.01	27x27x3.5

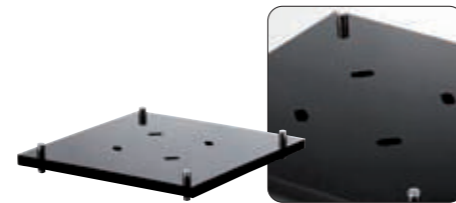

acrylic connector "Squareline"
black, glossy, with 4 stainless steel pins and 4 holes for cable run

item	l x w x h in cm
8083.02	27x27x3.5



buffet stand "Squareline"
massive stainless steel 18/10, highly polished, square, dishwasher-safe, food-safe

item	l x w x h in cm
8081.13	24x24x13.5
8081.25	24x24x25.5



buffet stand "Squareline"
massive stainless steel 18/10, white (powder-coated), square, not dishwasher-safe

item	l x w x h in cm
8084.13	24x24x13.5
8084.25	24x24x25.5



buffet stand "Squareline"
massive stainless steel 18/10, matt black (powder-coated), square, not dishwasher-safe

item	l x w x h in cm
8082.13	24x24x13.5
8082.25	24x24x25.5

Flexibility with a concept

"Curve" is made of 3 mm strong, galvanised steel with a high grade powder coating.

This guarantees great stability and corrosion-resistance. The gaps between the bars were expressly chosen by the Milanese designer Itamar Harari to make the raisers completely compatible with the systems "Skyline" (pages 18 to 23) and "Squareline" (pages 24 to 26). The attractively priced "Curve" is therefore not only suitable as a starter version,

but also as an optimal extension of existing systems. During the development of "Curve", special attention was given to the mobile usage. Thus all components can be stored in an extremely space-saving way. Simple and swift to install, "Curve" is the perfect equipment for outdoor areas, events and catering.

Our complete range of buffet platters is available on pages 50 bis 58.



buffet stand "Curve"
galvanised steel, 3 mm thick, matt black (powder-coated), not dishwasher-safe

item	l x w x h in cm	PU
8310.22	27x27x22.5	2 pcs
8310.46	27x27x46.5	2 pcs

Design: Itamar Harari



The "Zieher-System"

Zieher offers innumerable possibilities to present food optically appealing and highly flexible. When developing new buffet products, it is most important for Zieher to guarantee compatibility among the individual systems.

The "Zieher-System" with its different heights of 12, 24 and 36 cm or 8, 16, and 24 cm leads to a perfect composition of different presentation levels on the buffet, thus offering more

flexibility in its arrangement. A wide range of buffet platters and trays of hardened glass, natural slate and laminated plastic in various styles is available on pages 51 to 58.

Thanks to the boundless possibilities in varying materials and designs, every buffet can easily be adapted to any accommodation. The system becomes part of the whole interior and assimilates harmonically into any ambiance.

"Konkret!"

(from page 29 on)

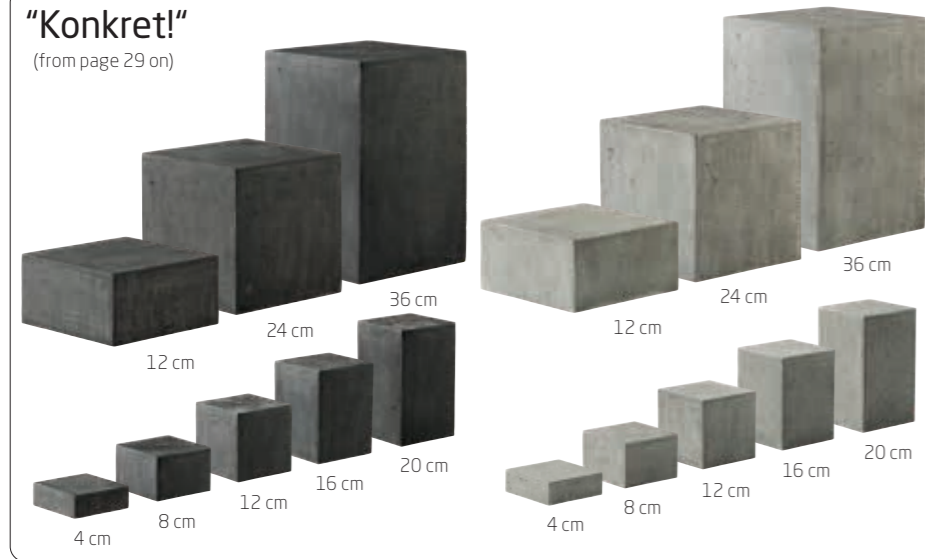

"StiXXX"

(page 41)

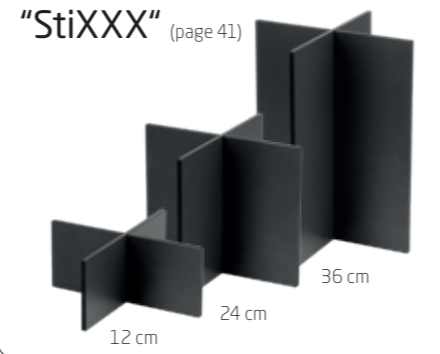

"Basic"

(from page 42 on)



"V12" - Carbon

(from page 34 on)

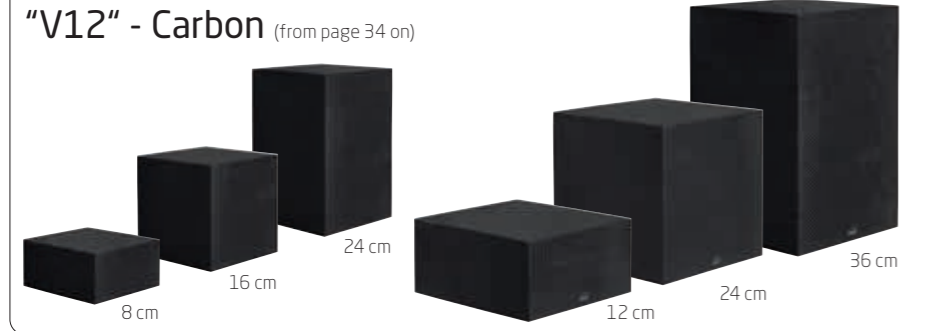

"Lightning Buffet"

(from page 47 on)



"Antique"

(page 46)



"Solid"

(page 40)



"Classy"

(from page 36 on)

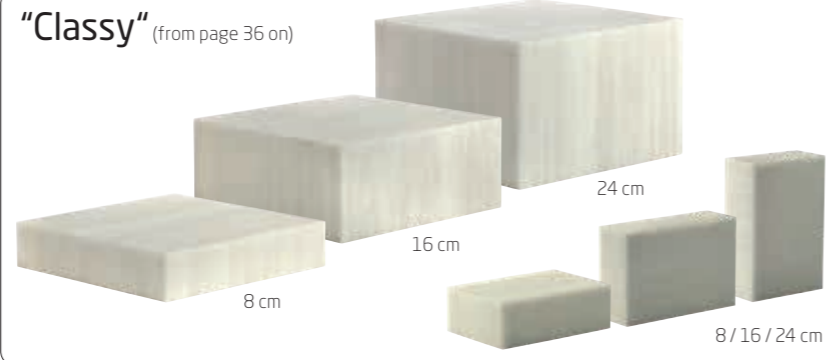

NEW

"Neo"

(from page 32 on)

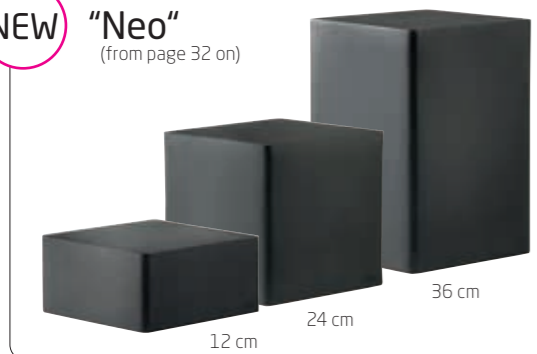

"Luxor"

(from page 38 on)

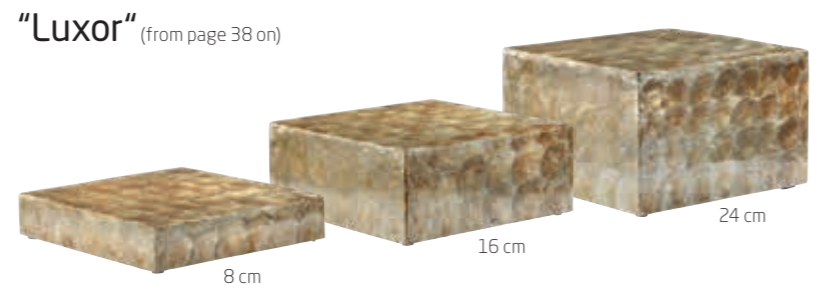

"Konkret!"



"Konkret!" - distinct design for highest flexibility!

Plain lines, neutral shapes and two different colour variations put your food presentation into focus and offer a maximum of flexibility, while at the same time, using the available space at your buffet most effectively. Maximum reduced shapes in combination with the rough look of concrete - "Konkret!" blends in particularly well with modern architecture. "Less is more" is the motto! Both variants of the displays (light grey and dark grey) are available in eight sizes, a dark grey XXL bowl impresses with huge size paired with light weight.



The XXL bowl "Konkret!" is available on page 31.



The displays consist of a mixture of fibreglass and stone and therefore offer the deceptively genuine optics of concrete combined with low weight and high stability, which greatly facilitates handling. The puristic flair of that system will be intensified by using glass platters. Those and other variations made of laminated plastic and slate are available on pages 50 to 58.

"Konkret!"



buffet display "Konkret!"

fibreglass/resin, dark grey (concrete look), not dishwasher-safe, splash-proof, hollow inside, bottom side open

item	l x w x h in cm	PU
8210.04D	12x12x4	2 pcs
8210.08D	12x12x8	2 pcs
8210.12D	12x12x12	2 pcs
8210.16D	12x12x16	2 pcs
8210.20D	12x12x20	2 pcs



buffet display "Konkret!"

fibreglass/resin, light grey (concrete look), not dishwasher-safe, splash-proof, hollow inside, bottom side open

item	l x w x h in cm	PU
8210.04L	12x12x4	2 pcs
8210.08L	12x12x8	2 pcs
8210.12L	12x12x12	2 pcs
8210.16L	12x12x16	2 pcs
8210.20L	12x12x20	2 pcs



buffet display "Konkret!"

fibreglass/resin, light grey (concrete look), not dishwasher-safe, splash-proof, hollow inside, bottom side open

item	l x w x h in cm
8200.12L	24x24x12
8200.24L	24x24x24
8200.36L	24x24x36



buffet display "Konkret!"

fibreglass/resin, dark grey (concrete look), not dishwasher-safe, splash-proof, hollow inside, bottom side open

item	l x w x h in cm
8200.12D	24x24x12
8200.24D	24x24x24
8200.36D	24x24x36

"Konkret!"

The XXL bowl in dark-grey concrete look inspires by its enormous size and the low weight. In empty state, it can easily be carried by one person. A filigree, but extremely solid stand made of powder-coated steel forms the perfect basis. A round glass plate separates ice from melting water and at the same time creates space for the Zieher rechargeable LED-light (page 49), which allows the illumination of the ice in striking colours. No matter if placed on the buffet table or on the stand - this bowl will leave a permanent impression on your guests!



XXL bowl "Konkret!"

fibreglass/resin, dark grey (concrete look), round, double-walled, not dishwasher-safe, waterproof-coated inside

item	Ø in cm	height in cm
8212.D	100	28

The separating plate is kept in position by a bearing edge integrated in the bowl.

The rechargeable LED-light item 8150 is available on page 49.



buffet platter/separating plate

hardened glass, 10 mm thick, satined, round, edge polished and deburred, separates ice and melt water

item	Ø in cm
5240.M	60



hand pump

highly elastic PVC, 2.5 mm thick, with hose, for easy drainage of melt water, professional quality, vacuum capacity: 10 l/min

item	Ø hose in cm	total length hose in cm
5662	2	250



rack for XXL bowls

steel, matt black (powder-coated), three-part for self assembly, adjustable feet for firm positioning on most surfaces, for XXL bowl "Konkret!" item 8212.D and XXL glass bowl item 5704

item	l x w x h in cm
8213	70x70x57



Cable notch for LED lamp 8104



buffet display "Neo"

resin, anthracite, matt finish, translucent, not dishwasher-safe, bottom side open, notch for cable on back side

item	l x w x h in cm
7002.12	24x24x12
7002.24	24x24x24
7002.36	24x24x36



buffet display/ice bucket "Neo"

Resin, anthracite, matt, translucent, not dishwasher-safe, open underside, with notch for cable on the back. Can be used on both sides!

item	l x w x h in cm
7005.16	53x32,5x16

Please note:



Isolated air inclusions in the material as well as slight colour deviations cannot be avoided due to production technology.



The buffet system "Neo" is made of anthracite coloured resin. The matt surfaces and softly rounded edges of these translucent cuboids appear unobtrusive and modern. "Neo" unfolds its true potential if the columns are effectively illuminated.

The optionally available LED-lights (pages 48 and 49), alternatively rechargeable or cabled, are the ideal completion to put "Neo" into its true light. Thanks to the battery-operated LED lights, which are waterproof to a depth of 1 metre and can be remote-controlled, even the ice in the ice containers can be illuminated from below – a truly fascinating sight. The large selection of different light colours enables spectacular effects!





buffet display "V12"
carbon fibre (fabric), high-gloss, black, not dishwasher-safe, splashproof, bottom side closed

item	l x w x h in cm
8206.08	20x20x8
8206.16	20x20x16
8206.24	20x20x24



buffet display "V12"
carbon fibre (fabric), high-gloss, black, not dishwasher-safe, splashproof, bottom side closed

item	l x w x h in cm
8205.12	24x24x12
8205.24	24x24x24
8205.36	24x24x36

"V12" combines modern and reduced forms with the precious material carbon. The elegant and three-dimensional look of the carbon fibre paired with maximum stability - "V12" adds high-tech to the buffet!

In connection with the huge Zieher assortment of buffet platters, "V12" provides a maximum in flexibility and best usage of buffet surfaces. Six different sizes of the "V12" displays offer a lot of possibilities for the individual composition of your buffet.

The standard heights of the carbon buffet displays of 12, 24 and 36 cm resp. 8, 16 and 24 cm permit an easy and simple combination with other Zieher systems. For an overview, please consult page 28.



The buffet stands "Basic" are available on page 42, buffet plates in many variants from pages 50 to 57.

"Classy"

The buffet displays "Classy" are made of translucent material and impress by their fascinating texture which is reminiscent of Italian marble or alabaster. The precise workmanship of the cubes as well as the silk-matt surface increase the fancy impression even more.

"Classy" is available in the Zieher system heights of 8, 16 and 24 cm and can therefore be combined in various ways. The open bottom side of the large displays allows an effective illumination by the optionally available LED-lights. With their different light colours, the LED-lights emphasise the appealing look and the interesting marbling of the material.

The small cube has no open underside and thus cannot be illuminated. The advantage of this construction lies in its high functionality. Its dimensions of 24 cm x 16 cm x 8 cm enable a positioning in 3 heights - a clever supplement to the squarish displays.

It is possible to stage "Classy" with or without lighting, strikingly eye-catching or quite discreetly. Whether unobtrusive and modern or playful and opulent - "Classy" fits perfectly into any ambience!

"Classy"



The LED-lights are available on pages 48 and 49.



The baskets of the "Reef" series are available on pages 70 to 73.



Closed on all sides, cannot be illuminated



buffet display "Classy"

resin, white, alabaster look, not dishwasher-safe, closed on all sides, can be used in any position

item	l x w x h in cm
8231	24x16x8



Notch for cable for LED-light item 8104



buffet display "Classy"

resin, white, translucent, alabaster look, not dishwasher-safe, bottom side open, notch for cable on back side

item	l x w x h in cm
8230.08	38x38x8
8230.16	38x38x16
8230.24	38x38x24



"Luxor"

The shimmering displays of the "Luxor" series enchant by the colour play of golden shades in variable nuances. This effect is created by high-quality shell imitations, which are arranged fan-shaped on a fibreglass base in sophisticated handcrafting. The honed and highly polished, multiple sealing with resin (Polyresin), emphasises the pattern and the pearlescent shine of the gold-coloured discs and provides the surface with a striking depth effect.

The buffet cuboids are available in heights of 8, 16 and 24 cm and are therefore compatible with many other displays of the Zieher system. The 38 cm x 38 cm large bearing surface can be used directly for presentation purposes or as a basis for buffet platters or stairs of various kinds.

"Luxor" adds a touch of extravagance to both the modern and classic ambiance, setting extraordinary accents in any environment.

"Luxor"



Buffet bowls made of grey glass are available on pages 78 to 83.



The glass tubes of the "Flex" series are available on page 212.



buffet display "Luxor"
high-quality shell imitation, golden, washable, bottom side open, with 4 resin feet, not dishwasher-safe

item	l x w x h in cm
8221.08	38x38x8
8221.16	38x38x16
8221.24	38x38x24



"Solid"



Please note the care instructions!
Not dishwasher-safe, do not immerse in water!

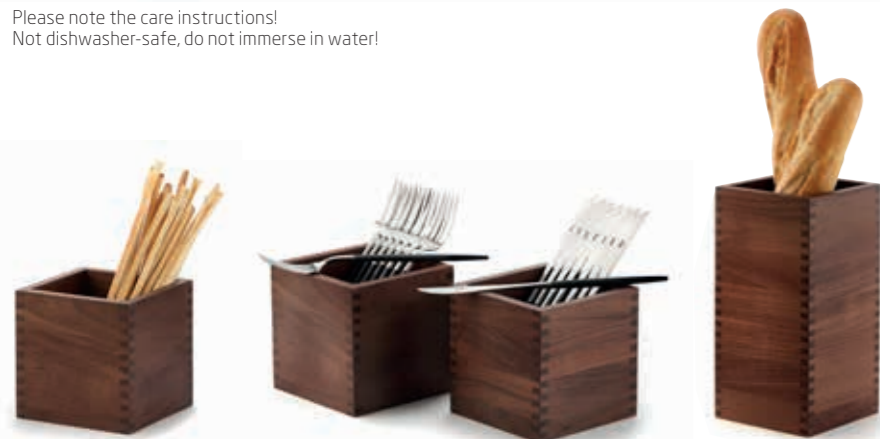

The buffet displays of the "Solid" series are, as all the other items of this series, made of solid walnut wood. They may be used as containers for cutlery or French bread, but they are particularly suitable for the elevation of the "Modul" walnut trays (page 136) or other buffet platters.

The filigree finger joints at the corners testify to precise craftsmanship of the highest quality and guarantee perfect stability!

The displays made of solid wood are visually appealing and fit perfectly into the existing buffet systems "Solid" and "Mercato" (pages 110 to 125).

buffet display "Solid"

walnut, food-safe sealed, not dishwasher-safe, bottom side open, can be used as a stand or as a container

item	l x w x h in cm	PU
4767.12	12x12x12	2 pcs
4767.24	12x12x24	2 pcs



More displays and buffet systems made of walnut are available from page 110 on.

"StiXXX"

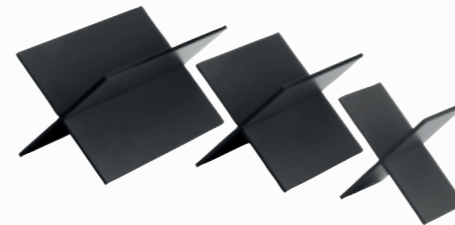

buffet display "StiXXX"

laminated plastic, 8 mm thick, dark grey, black intermediate ply, break-proof, scratch-proof, dishwasher-safe, antistatic, deburred edges, rounded corners, pluggable, 1 set (2 parts)

item	l x w x h in cm
8060.12	20x20x12
8060.24	20x20x24
8060.36	20x20x36

The indestructibility of laminated platters meets the advantages of plug-in systems. The plain displays are loosely stuck together, which ensures a quick and uncomplicated setup as well as a space-saving storage of the single components. Thereby "StiXXX" meets in particular the hard requirements of daily use in the catering business.

The heights of the puristic displays match perfectly with other series of the Zieher-System, by what creates numerous possible variants. Positioned as an "X" results in further presentation possibilities with a particularly slight and filigree alignment. The Zieher buffet platters and displays made of laminate are usable on both sides by the double-sided decoration. This exceedingly robust raw material is break- and scratch-proof, antistatic and dishwasher-safe and thus offers numerous advantages compared to other raw materials.

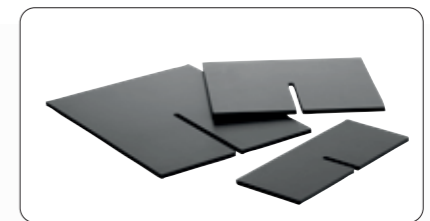

Special decor "Industry 2.0" (page 53) upon request.

The trays made of grey glass are available on page 165. Buffet platters made of laminated plastic are available on page 52/53.





Food: Pâtisserie Walter (www.patisserie.de)

The card holder made of stainless steel is available on page 106.



"Basic" & "Konkret!"



buffet stand "Basic"
stainless steel 18/10 brushed (pipe Ø 3.2 cm), with felt pad at the top (black)

item	Ø in cm	height in cm	PU
8080.04	7	4	2 pcs
8080.08	7	8	2 pcs
8080.16	7	16	2 pcs
8080.24	7	24	2 pcs

"Basic" is the simple and flexible solution to create different presentation levels. The high-quality columns made of matt brushed stainless steel (18/10) are a fitting base for buffet platters made of glass and other materials. The columns are fitted with felt pads on the top to protect the surface of glass platters and to level out any unevenness of the tables. The feet with 7 cm in diameter guarantee firm standing.

The unobtrusive and unadorned design of the buffet stands puts food and drinks into the limelight.

"Basic" is available in four heights and can be combined with several Zieher buffet systems (page 28). The carbon buffet stands "V12" presented here can be found on pages 34 and 35.

Please note:

We do not recommend the use of "Basic" in combination with buffet platters made of natural slate. Due to the slightly varying thickness of natural slate platters, this combination might shake.



"Basic" & "V12" Carbon

"Chiller-Base"



Cooling pillows

The cooling pads have been tailor-made for the melamine base to provide for an optimal cooling surface by the perfect fit. The pads can optionally be flipped, depending on whether the black top or the white bottom fits into the overall picture more harmoniously. So, they are applicable inconspicuously, even with slightly translucent or satined buffet platters.

The attractive contrast of top and bottom can also be used on the laid table to deliberately set accents. Serving chilled food becomes a visual highlight. The high-quality case made of black or white nylon fabric looks very noble and yet discreet. It is filled with gel, which remains malleable, even when frozen and thus allows an adaptation to a wide variety of tableware used.



cooling pack
nylon, black/white, non-toxic cooling gel

item	l x w in cm
5663.20	20x20



chiller base/tray
melamine, square, for cooling pack item 5663.20

item	colour	l x w x h in cm
4597.01	black	41x41x3.5
4597.02	white	41x41x3.5

Buffet platters made of glass in the formats 42 cm x 42 cm and 50 cm x 50 cm can be found on pages 54 to 57.



Precise recesses on the underside facilitate positioning



The porcelain bowl "Cave" is available on page 163.

"Chiller-Base"



The "Textura" buffet displays are available on page 12 / 13.

"Chiller-Base" - just stay cool!

The cooling elements by Zieher are an elegant and simple solution for a quick and flexible installation of chilled platters. They can be arranged either at different heights by using displays or freely positioned on the buffet table.

The flat bowls are available in matt black and white melamine and have been designed specifically for food whose presentation can be extended significantly by cooling.

The puristic form, the compact height of only 35 mm as well as the restrained colouring allow a stylishly discreet integration into numerous buffet constructions. Tailored recesses on the underside of the trays facilitate symmetrical positioning on most Zieher buffet systems. So a harmonious overall picture can be achieved quickly. Unobtrusive rubber buffers in the corners of the "Chiller-Base" ensure a non-slip and secure fit of laid-up platters in sizes starting from 42 x 42 cm (page 54 - 57).



"Skyline", page 18 - 22

"Skyline", page 18 - 22

"Squareline", page 24 - 26

"Basic", page 42 / 43

"Konkret!", page 29 / 30



Notch for cable for LED-light item 8104 (page 48)



buffet stand "Antique"

polyresin sandstone mixture, sandy colour, hollow inside, notch for cable on back side

item	Ø in cm	height in cm
8011.12	12.5	12
8011.24	12.5	24
8011.36	12.5	36

Please note:



Due to the density of the material, the glow may be limited.



Bringing light into the darkness!

The illuminated buffet stands, in connection with platters made of natural slate, laminated plastic or glass (pages 50 to 57), make every buffet shine in a radiant new light. The innovative LED technology does not radiate any heat and is powered by a harmless voltage. It is characterised by its longevity and its low power consumption. The standard light of the cabled LED is white, but thanks to the coloured plastic covers, the colour scale is enlarged to contain red, yellow, green and blue (page 48).

Alternatively, there is a rechargeable LED-light with several different functions available. Besides a fixed colour range and special programs, its particular feature is a remote control that enables changing colours and programs during use. For a detailed description of this LED-light and its functions, please check out page 49.

The columns made of satined acrylic (page 48) are available in seven sizes and feature a removable cover to enable the insertion of round bowls.



The decanters "Star" and "Eddy" are available on page 196 und 197.



XXL bowl glass, page 79



"Squareline", page 24 to 26



"Stablo" page 59 to 63

LED-light with cable, item 8104...

For permanently installed buffets which are not dismantled on a daily basis, it is recommended to use the LED-light with cable item 8104.

The standard light is white; the alternative colours blue, yellow, green and red can be chosen by using the precisely fitting plastic covers items 8105... (available as accessories).

A set consists of 3 lights and the matching power supply, which can be fitted with a total of 6 lights. All cables are white and the power cable of the light has a length of 3 metres, which is enough to stow away adapter and power supply safely and invisibly under the buffet table.



LED-light

white light, set of 3 LED-lights including power supply (cable), sixfold junction for up to 6 lights, 100-240 V, 50/60 Hz, Ø 9.7 cm, 2 cm high

item	power plug
8104	Europe
8104.UK	UK
8104.USA	USA



colour cover

plastic, for LED-light items 8104..., Ø 10 cm

item	colour	PU
8105.01	blue	3 pcs
8105.02	yellow	3 pcs
8105.03	green	3 pcs
8105.04	red	3 pcs



Please note: The luminosity depends on the spatial realities; the actual colouring may deviate from the colours shown in the pictures!



The height of the columns items 8122... have been adjusted especially for the illumination of the "Skyline" buffet system. The lids of all acrylic glass tubes are removable. Therefore the tubes can also function as supports for plates, bowls, etc



acrylic glass tube

satined (white), removable lid for easy fitting of bowls etc., notch for cable for LED-light item 8104 (not included, please order separately)

item	Ø in cm	height in cm	PU
8122.10	12	10	3 tubes
8122.22	12	22	3 tubes
8122.34	12	34	3 tubes
8122.58	12	58	3 tubes



acrylic glass tube

satined, white, removable lid for easy fitting of bowls etc., notch for cable for LED-light item 8104 (not included in delivery, please order separately)

item	Ø in cm	height in cm	PU
8120.01	15	12	3 tubes
8120.02	15	24	3 tubes
8120.03	15	36	3 tubes



Waterproof up to a depth of 1 metre!



The entire instruction sheet with a detailed description of all functions is available at https://www.zieher.com/fileadmin/ZieherUploads/Bedienungsanleitungen/Bedienungsanleitung_Akku_LED_Leuchte__8150_.pdf

Rechargeable LED-light with radio remote control:

The compact LED-light is controlled by remote control, which allows for a more flexible use of the Zieher "Lightning Buffet" and renders it independent from any power supply and spatial requirement.

This creates a lot of new possibilities for the buffet setup: out in the open, next to the pool or in the middle of the room - without any troublesome cables and controllers that might get into the guests' or the personnel's way. The necessary radio remote control item 8151 (to be ordered separately) rounds off the whole system in regard to function and handling and allows to choose the colouring within a range of up to 15 m without dismantling the buffet first. Due to many different colours and special programs, the buffet will fit into every kind of atmosphere. The lighting colour for the complete buffet can be changed by pressing only one button. Experience the "Lightning Buffet" - no matter where - you will be excited!



Please note: The luminosity depends on the spatial realities; the actual colouring may deviate from the colours shown in the pictures!



remote control

for rechargeable LED-light item 8150, white with grey cord

item	l x w x h in cm
8151	8.5x5.2x2.8



rechargeable LED-light

remote-controlled, 3 different degrees of brightness (only selectable on the light directly), 7 fixed colours (white, green, red, blue, yellow, violet, turquoise) and additionally: candle flickering, colour gradient and colour change (only selectable by remote control item 8151, please order separately)

item	Ø in cm	height in cm
8150	9.5	3



charging device for rechargeable LED-light

white, with handy cable spool (1.5 m of cable), wall fixing possible, 3 anti-slip rubberfeet, Ø 13 cm, 2 cm high

item	power plug
8152.EU	Europe
8152.UK	UK
8152.US	USA

- 7 fixed colours and 3 special programs, manageable via remote control (white, green, red, blue, yellow, violet, turquoise, flickering-candle-effect, colour change, colour gradient)
- 3 different brightness-settings selectable (100 % - 70 % - 50 %, only adjustable directly)
- Fixedly integrated high-performance batteries guarantee a running-time of up to 20 hrs (at the lowest brightness-setting)
- LED-light waterproof up to a depth of 1 m
- Remote control (to be ordered separately) controls up to 20 LED-lights simultaneously / range up to 15 m
- Charging device can be mounted on a wall and features a space-saving cable spool

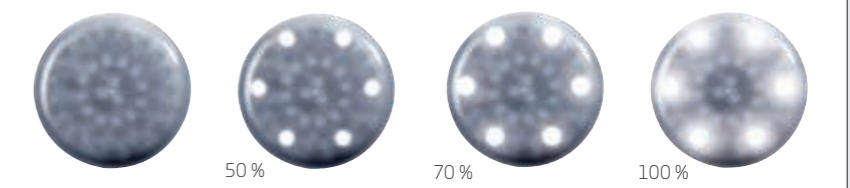

brightness-setting at the light



cable spool on charging station



recharging control light

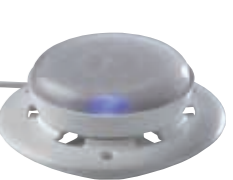

Buffet platters and more!

Zieher is offering a wide range of buffet platters made of laminated plastic, several kinds of glass and natural slate. Due to the wide choice of formats and types of materials, there are many possibilities of combinations with Zieher's buffet systems (pages 5 to 48). The offer is being completed by various buffet stairs, trays and bowls (pages 58 to 94).

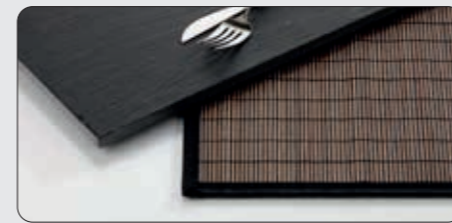

Buffet platters made of slate!

- Natural slate
- Food-safe sealed/unsealed
- 10 to 15 mm thick
- With rubber feet



Natural slate, page 51

- Food-safe sealed/unsealed
- 10 - 15 mm thick
- With rubber feet



Laminated plastic, page 52

- Dark grey resp. black, black intermediate ply
- 8 mm thick
- Break-proof
- Dishwasher-safe
- Scratch-proof
- Antistatic

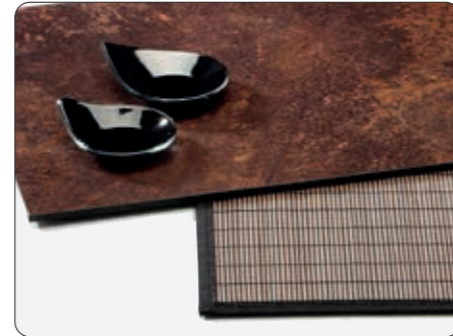

Laminated plastic, page 53

- Matured wood look, or rusted look, black intermediate ply
- 8 mm thick
- Break-proof
- Dishwasher-safe
- Scratch-proof
- Antistatic

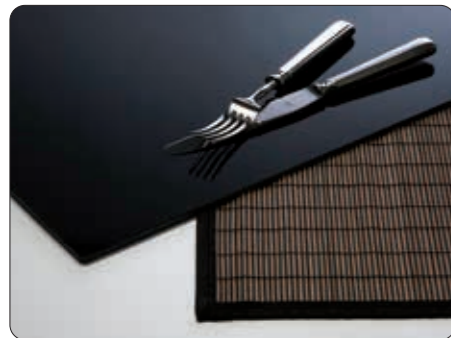

Black glass, page 54

- Specially hardened safety glass
- 4 mm thick, low weight
- Edges polished and rounded
- Underside scratch-resistant, black
- Shock-proof, heat-resistant
- Dishwasher-safe

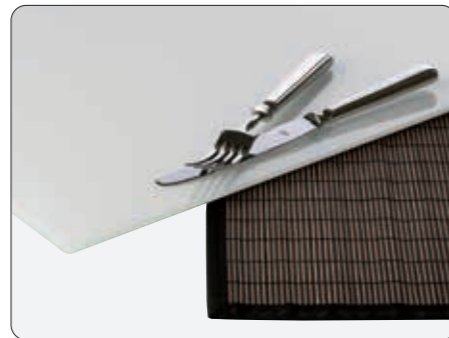

White glass, page 55

- Special hardened safety glass
- 4 mm thick, low weight
- Edges rounded and polished
- Underside scratch-resistant, white
- Shock-proof, heat-resistant
- Dishwasher-safe

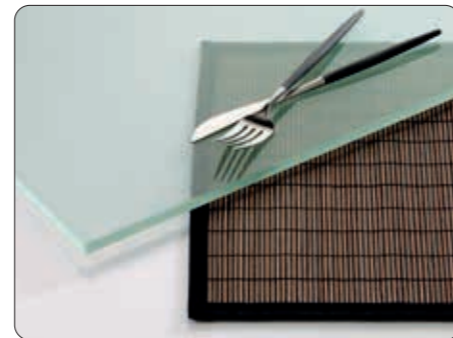

Satin glass, page 56

- Specially hardened safety glass
- 10 mm thick
- Edges polished and deburred
- Underside satin
- Dishwasher-safe

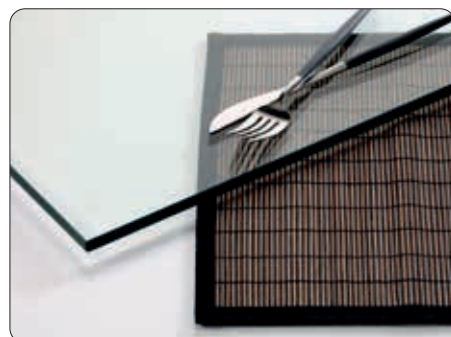

Transparent glass, page 56

- Specially hardened safety glass
- 10 mm thick
- Edges polished and deburred
- Dishwasher-safe

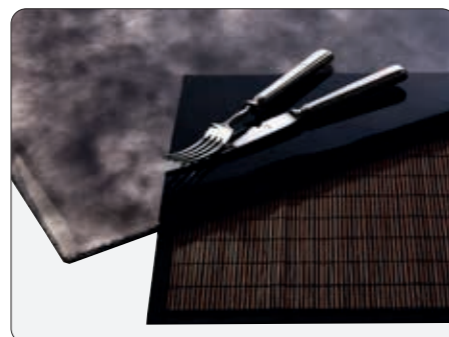

Structured glass, page 57

- Special hardened safety glass
- 5 or 8 mm thick (depending on size)
- Edges rounded
- Underside structured
- Irregular colouring in cloudy optic
- Dishwasher-safe



Dark grey glass, page 57

- Specially hardened safety glass
- 10 mm thick, transparent
- Edges polished and deburred
- Dishwasher-safe

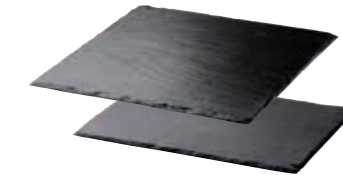

charger plate, slate

natural slate, approx. 5 mm thick, food-safe (sealed), not dishwasher-safe, with rubber feet

item	version	l x w in cm
2543.30	square	30x30
2544.30	rectangular	30x20



buffet platter 1/1 GN, slate

natural slate, 10 to 15 mm thick, unsealed, not dishwasher-safe, rectangular, with rubber feet

item	l x w in cm
8020	53x32.5

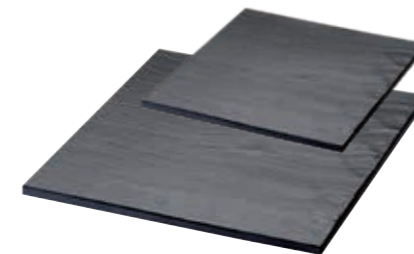

buffet platter, slate

natural slate, 10 to 15 mm thick, food-safe (sealed), not dishwasher-safe, with rubber feet

item	version	l x w in cm
8005.01	square	50x50
8005.04	square	42x42
8005.05	rectangular	42x34
8005.06	square	34x34
8005.07	rectangular	60x40



buffet platter, slate

natural slate, 10 to 15 mm thick, food-safe (sealed), not dishwasher-safe, round, with rubber feet

item	Ø in cm
8005.21	60

Slate is a unique and exceptional natural product. The surfaces of our slate plates have the typical cleavage. Every piece is unique. Small deviations in structure, thickness (10 to 15 mm) and weight of the platters cannot be avoided, as it is in the nature of the product. Also, there could be single inclusions of other minerals and fossils. These exceptional features give slate its precious and vivid appearance. Please note: Specific groceries, especially those that contain fruit acid (citric acid) may damage the surface in case of prolonged contact. Therefore we recommend avoiding any direct contact with edibles.



Buffet platters made of laminated plastic!

- Dark grey resp. black, black intermediate ply
- 8 mm thick
- Break-proof
- Dishwasher-safe
- Scratch-proof, antistatic



Buffet platters made of laminated plastic!

- Rusted look, black intermediate ply
- 8 mm thick
- Break-proof
- Dishwasher-safe
- Scratch-proof, antistatic



The buffet crosses "StiXXX" made of laminated plastic are available on page 41.



The glass "Amuse" is available on page 215.



buffet platter, laminated plastic

laminated plastic, 8 mm thick, dark grey, black intermediate ply, break-proof, scratch-proof, dishwasher-safe, antistatic, deburred edges, rounded corners

item	version	l x w in cm
8006.01	square	50x50
8006.02	rectangular	50x42
8006.04	square	42x42
8006.06	square	34x34
8006.08	rectangular	80x21
8006.11	1/1 GN	53x32.5
8006.13	rectangular	95.4x39
8006.14	rectangular	91x21
8006.15	rectangular	102x21



NEW

buffet platter, laminated plastic

laminated plastic, 8 mm thick, black, black intermediate ply, break-proof, scratch-proof, dishwasher-safe, antistatic, deburred edges, rounded corners

item	version	l x w in cm
8010.01	rectangular	41x17
8010.02	rectangular	49x25
8010.03	rectangular	49x33

The black buffet panels 8010... are sized to fit the LED displays „Glow“. They are available as of page 8.

The charm of transience

Break- and scratch-resistant, anti-static and dishwasher-safe – these features of laminated plastic platters and the resulting advantages are convincing!

The buffet platters made of laminated plastic are available in two neutral versions as well as in an extraordinary variation.

Unplastered brick-lined walls, load-bearing structural elements made of steel beams, exposed concrete and the morbid charms of abandoned factory buildings create the ambience for the rust-coloured decoration "Industry 2.0". This is evocative of weathered steel surfaces, which are marked by decades of corrosion and fits perfectly into the industrial style of modern architecture.

All laminated buffet platters by Zieher have a dark middle layer and can be used on both sides because of their double-coating.

Please note:



With these decors, each plate is unique – none of them look alike.

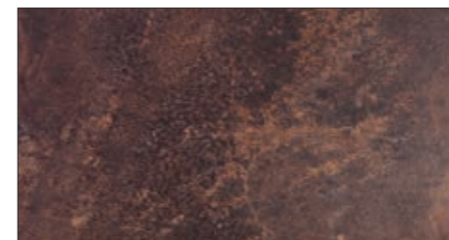

buffet platter "Industry 2.0"

laminated plastic, 8 mm thick, rusted look, black intermediate ply, break-proof, scratch-proof, dishwasher-safe, antistatic, deburred edges, rounded corners

item	version	l x w in cm
8007.01	square	50x50
8007.02	rectangular	50x42
8007.04	square	42x42
8007.06	square	34x34
8007.08	rectangular	80x21
8007.11	1/1 GN	53x32.5
8007.13	rectangular	95.4x39

All information about the displays of the "Crossline" series are available on pages 16/17.

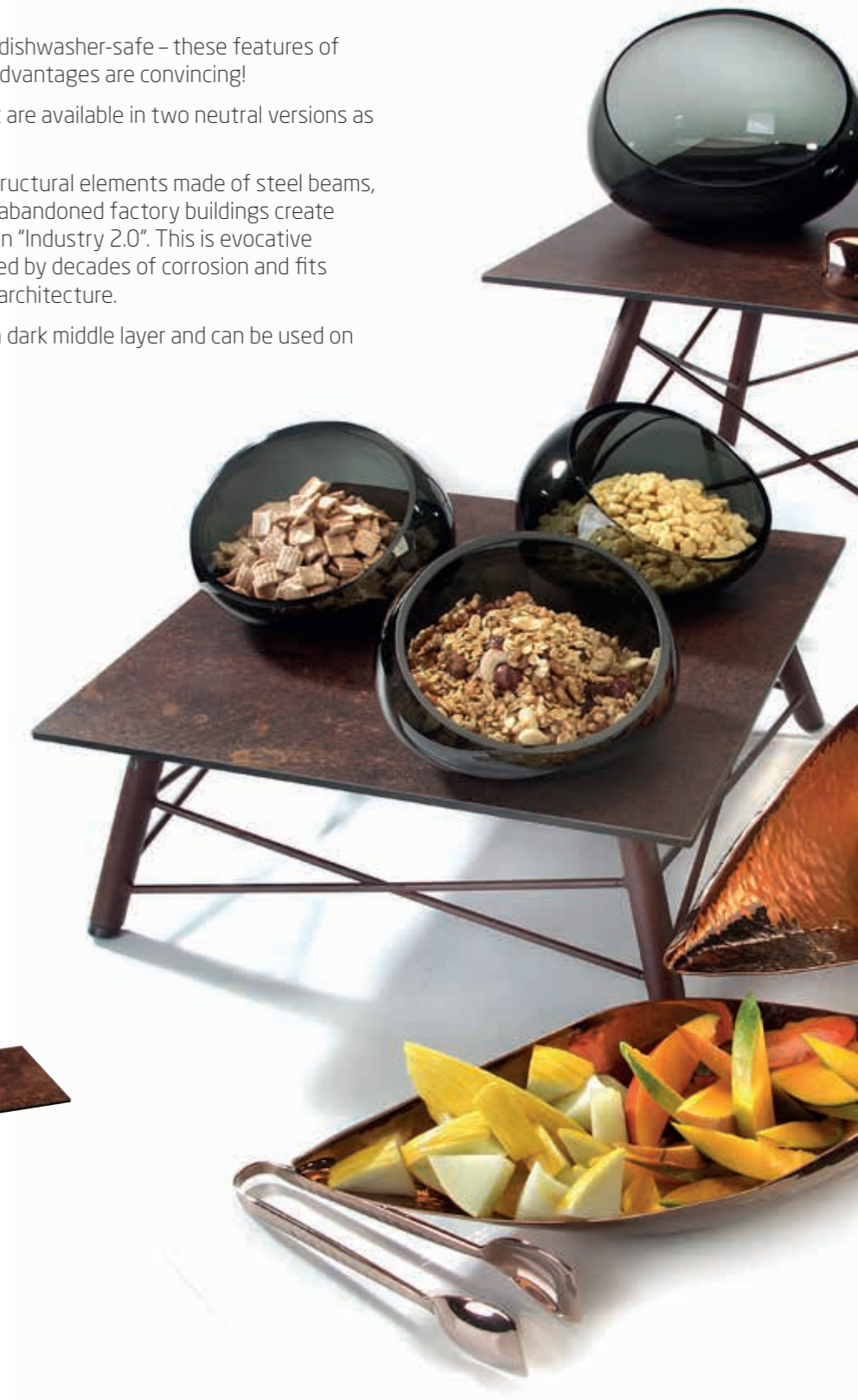

Buffet platters made of black glass!

- Special hardened safety glass
- 4 mm thick, low weight
- Edges rounded and polished
- Underside scratch-resistant, black
- Shock-proof, heat-resistant, dishwasher-safe



The buffet system "Konkret!" is available on page 29.



buffet platter, black glass

special hardened safety glass, 4 mm thick, black, rounded edges, polished rim, dishwasher-safe, rubber feet included (adhesive), underside scratch-proof

item	version	l x w in cm
1668.01	square	50x50
1668.03	rectangular	50x34
1668.04	square	42x42
1668.05	rectangular	42x34
1668.06	square	34x34
1668.08	rectangular	80x21
1668.09	rectangular	80x40
1668.10	rectangular	30x18
1668.22	rectangular	91x21
1668.24	rectangular	102x21

NEW

buffet platter, black glass

special hardened safety glass, 4 mm thick, black, with 2 concave cutouts, rounded edges, polished rim, dishwasher-safe, rubber feet included (adhesive), underside scratch-proof

item	l x w in cm
1668.20	49x21

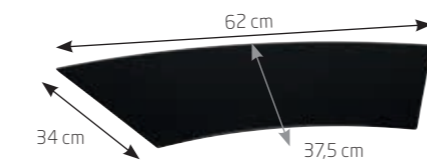

buffet platter Curve 45°

special hardened safety glass, 4 mm thick, black, curved shape, rounded edges, polished rim, dishwasher-safe, rubber feet included (adhesive), underside scratch-proof

item	l x w in cm	PU
1668.14	62x37.5	2 pcs

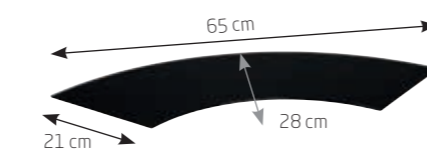

buffet platter Curve 90°

special hardened safety glass, 4 mm thick, black, curved shape, rounded edges, polished rim, dishwasher-safe, rubber feet included (adhesive), underside scratch-proof

item	l x w in cm	PU
1668.15	65x28	2 pcs



buffet platter, black glass

special hardened safety glass, 4 mm thick, black, round, edges polished, dishwasher-safe, with rubber feet (adhesive), underside scratch-proof

item	Ø in cm
1669.33	33
1669.53	53

Buffet platters made of white glass!

- Special hardened safety glass
- 4 mm thick, low weight
- Edges rounded and polished
- Underside scratch-resistant, white
- Shock-proof, heat-resistant, dishwasher-safe



buffet platter, white glass

special hardened safety glass, 4 mm thick, white, rounded edges, polished rim, dishwasher-safe, rubber feet included (adhesive), underside scratch-proof

item	version	l x w in cm
1670.01	square	50x50
1670.03	rectangular	50x34
1670.04	square	42x42
1670.06	square	34x34
1670.08	rectangular	80x21
1670.09	rectangular	80x40
1670.10	rectangular	30x18
1670.12	rectangular	66x10

buffet platter, white glass

special hardened safety glass, 4 mm thick, white, with 2 concave cutouts, rounded edges, polished rim, dishwasher-safe, rubber feet included (adhesive), underside scratch-proof

item	l x w in cm
1670.20	49x21

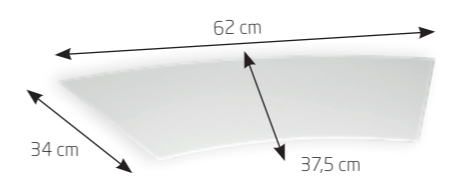

buffet platter Curve 45°

special hardened safety glass, 4 mm thick, white, curved shape, rounded edges, polished rim, dishwasher-safe, rubber feet included (adhesive), underside scratch-proof

item	l x w in cm	PU
1670.14	62x37.5	2 pcs

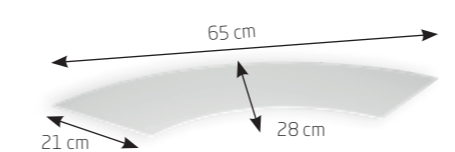

buffet platter Curve 90°

special hardened safety glass, 4 mm thick, white, curved shape, rounded edges, polished rim, dishwasher-safe, rubber feet included (adhesive), underside scratch-proof

item	l x w in cm	PU
1670.15	65x28	2 pcs



buffet platter, white glass

special hardened safety glass, 4 mm thick, white, round, edges polished, dishwasher-safe, with rubber feet (adhesive), underside scratch-proof

item	Ø in cm
1671.33	33
1671.53	53

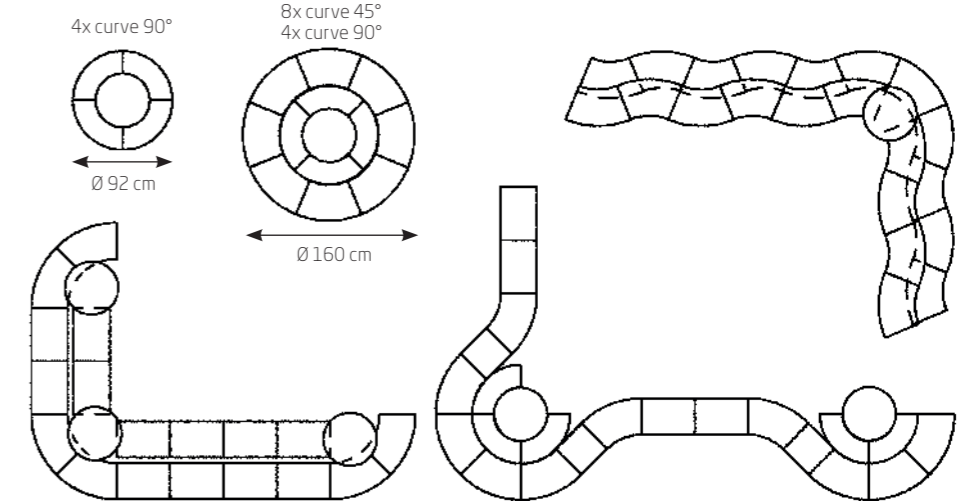

The curved platters combined with compatible buffet platters and buffet stands allow innumerable variations! These platters are available in black glass (page 54), white glass (page 55) and transparent glass (page 56).



The buffet system "Basic" is available on page 42, the miniatures made of glass on pages 220 to 225.

Buffet platters made of satined glass!

- Special hardened safety glass
- 10 mm thick
- Edges polished and deburred
- Underside satined
- Dishwasher-safe

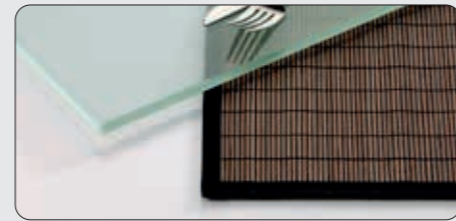

buffet platter, satined glass
hardened glass, 10 mm thick, satined, edges polished and deburred

item	version	l x w in cm
5243.M	rectangular	80x21



buffet platter, satined glass
hardened glass, 10 mm thick, satined, round, edges polished and deburred

item	Ø in cm
5240.M	60

Buffet platters made of structured glass!

- Special hardened safety glass
- 5 or 8 mm thick (depending on size)
- Edges rounded, underside structured
- Irregular colouring in cloudy optic
- Dishwasher-safe

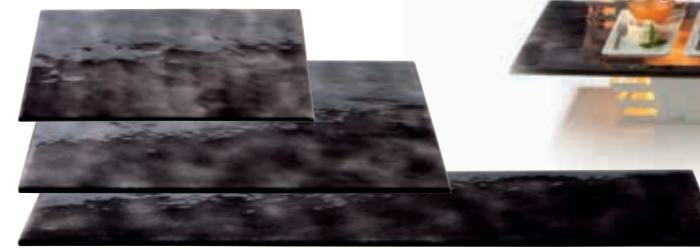

buffet platter
hardened glass, grey transparent, irregularly coloured in a cloudy look, underside structured, dishwasher-safe, scratch-proof

item	version	l x w in cm	thickness in mm
8008.01	square	50x50	8
8008.02	rectangular	50x42	8
8008.03	rectangular	50x34	8
8008.04	square	42x42	5
8008.05	rectangular	42x34	5
8008.06	square	34x34	5
8008.07	2/1 GN	65x53	8
8008.08	rectangular	80x21	8
8008.13	rectangular	95.4x39	8

Each piece is unique!

The irregular colouring of the Zieher buffet platters is created by colour pigments, which are manually applied and fused into the glass. The colour is fixed inside the glass and therefore dishwasher-safe and abrasion resistant. Structured underside and rounded edges emphasise the effect of the platters and the individual and interesting shades of grey and intensity of colour create unique patterns in each platter!

Buffet platters made of transparent glass!

- Special hardened safety glass
- 10 mm thick
- Edges polished and deburred
- Dishwasher-safe

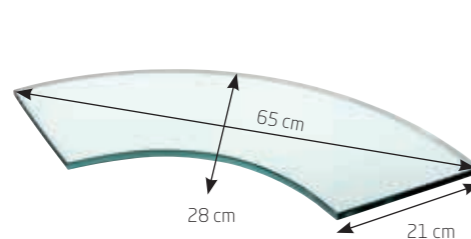

buffet platter Curve 90°
hardened clear glass, 10 mm thick, curved shape, edges polished and deburred

item	l x w in cm	PU
5241	65x28	2 pcs



buffet platter Curve 45°
hardened clear glass, 10 mm thick, curved shape, edges polished and deburred

item	l x w in cm
5242	62x37.5

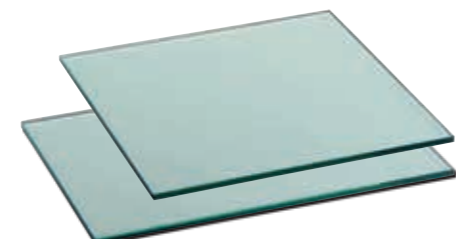

buffet platter, clear glass
hardened glass, 10 mm thick, edges polished and deburred

item	version	l x w in cm
8004.01	square	50x50
8004.02	rectangular	50x42
8004.03	rectangular	50x34
8004.04	square	42x42
8004.05	rectangular	42x34
8004.06	square	34x34
5243	rectangular	80x21
5000	rectangular	95.4x39



charger plate/glass insert
hardened clear glass, 6 mm thick, round, edge polished and deburred

item	Ø in cm
4999	33

Buffet platter made of dark grey glass!

- Special hardened safety glass
- 10 mm thick
- Edges polished and deburred
- Dark grey, transparent
- Dishwasher-safe

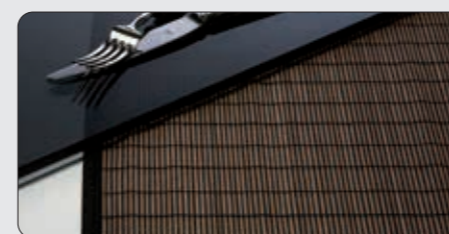

buffet platter, dark grey glass
hardened glass, 10 mm thick, dark grey, edges polished and deburred

item	version	l x w in cm
8004.07B	2/1 GN	65x53



The tray stand "Solid" is available on page 236.

Glass steps and more!



The buffet system "Skyline" is available on pages 18 to 23.

"Stablo"



glass tray

glass, dark black, useable for buffet, flying buffet or as a tray

item	l x w x h in cm	version
5142.34	35x35x2	square
5141.50	51x35x2	rectangular



glass steps

5026.01: 32 cm long, 34 cm wide (horizontal position) 5026.02: 55 cm long, 42 cm wide (horizontal position)

item	l x w x h in cm (glass step)	thickness in mm
5026.01	32x34x3.5	6
5026.02	55x42x4	8



glass steps

wavy, 7 steps, delivered in a wooden box, horizontal length: 67 cm/vertical length: 65 cm

item	version	width in cm
5076.01	clear	40

glass steps

deep black 5026.03: 32 cm long, 34 cm wide (horizontal position) 5026.04: 55 cm long, 42 cm wide (horizontal position)

item	l x w x h in cm (glass step)	thickness in mm
5026.03	32x34x3.5	6
5026.04	55x42x4	8

Please note:



The glass steps items 5026... are adjusted to the Zieher system and due to their height of 12 resp. 24 cm can easily be combined with many Zieher buffet raisers (page 28).

All large steps are supplied in a sturdy wooden box!

"Stablo" – filigree versatility

The buffet stands made of solid, brightly polished stainless steel impress by their high-quality workmanship and delicate appearance. Bowls and dishes appear almost hovering while slip-proof caps on the feet ensure safe support. The height of the stand (item 8016.01) is adjustable via extensions from 80 cm to 120 cm. Massive and bulky buffet tables become virtually redundant!

The buffet stand with its integrated ring (item 8016.01), allows for the presentation of plates and platters (max. dia. 21 cm on the lower level), but also for the insertion of extravagant wine coolers made of borosilicate glass. The coolers, positioned at an angle, may also be used with the "Stablo" stands in the sizes M and L.

The shape of the cooler corresponds to the already well-known Zieher glass cloches (pages 173 to 176), thicker quality borosilicate glass ensures the necessary stability! Due to its shape, any condensing water on the outside is drained off to the bottom tip. Dripping water can easily be caught by placing a small bowl on the floor or the buffet table. The integration of the optionally available Zieher rechargeable LED-lights creates breathtaking visual effects and puts champagne but also iced food in the limelight!



A three-staged buffet etagere is offering a lot of space for all kinds of food. It can be equipped with numerous trays and plates of the Zieher range. Anti-slip caps avoid annoying noise and ensure the safe grip of the trays



The etagere with suitable trays is available on pages 62 und 63.



wine cooler

borosilicate glass, transparent, handblown, handmade, reinforced version, for "Stablo" M, L items 8015.30 and 8015.40 (by positioning the cooler at an angle) and "Stablo" XL ring item 8016.01

item	Ø in cm	height in cm
4881.26	26	approx. 43

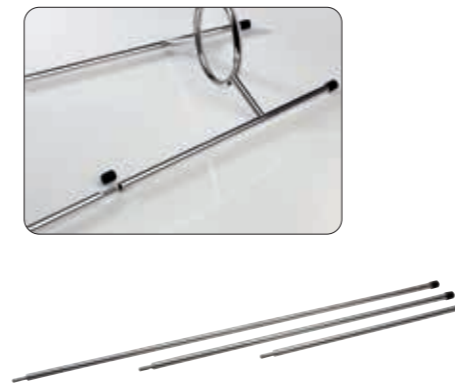

extension "Stablo"

massive stainless steel 18/10, polished, 12 mm thick, with anti-slip rubber caps, for buffet stand "Stablo" item 8016.01 (not suitable for items 8014... and 8015...)

item	length in cm	PU
801740	40	1 set (3 parts)
801760	60	1 set (3 parts)
801780	80	1 set (3 parts)

Extension for buffet stand XL ring

801740: for a total height of 80 cm
801760: for a total height of 100 cm
801780: for a total height of 120 cm

Please note: For one buffet stand "Stablo" XL ring item 8016.01 only one set of extensions is required.



Also available separately on request

buffet stand "Stablo" XL-ring

massive stainless steel 18/10, polished, 12 mm thick, with ring-opening (Ø 12 cm inside) for wine cooler items 4881.26, with 6 anti-slip rubber caps, 3 of which are separately packed (to clip onto the bottom part while not using the extensions items 8017... please order the extensions separately)

item	Ø upper/lower in cm	height in cm	PU
8016.01	22.5/37	40	3 pcs



By positioning the cooler at an angle it is also suitable for buffet stands "Stablo" M and L.



buffet stand "Stablo" S, M, L

massive stainless steel 18/10, polished, 10 mm thick, with 6 anti-slip rubber caps

item	Ø upper/lower in cm	height in cm	PU
8015.20	22/30	20 / S	3 pcs
8015.30	22/35	30 / M	3 pcs
8015.40	22/39	40 / L	3 pcs



buffet stand "Stablo" XS, XXS

massive stainless steel 18/10, polished, 8 mm thick, with 6 anti-slip rubber caps

item	Ø upper/lower in cm	height in cm	PU
8014.13	15/20,5	13.5/XXS	3 pcs
8014.20	15/23	20/XS	3 pcs

The rechargeable LED-light item 8150 and suitable accessories are available on page 49.



Instruction sheet with detailed description: https://www.zieher.com/fileadmin/ZieherUploads/Bedienungsanleitungen/Bedienungsanleitung_Akku_LED_8150.pdf



Positioning of ring and light



ring "SelectionA."

silicone, Ø 8.3 cm

item	colour	PU
4681.S	black	6 pcs



The buffet etagere item 2193.02 in hammered look is available on page 105.

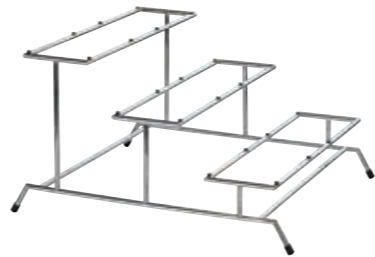

buffet etagere "Stablo"

massive stainless steel 18/10, 10 mm thick, with 4 anti-slip rubber caps and 24 rubber pads (for anti-slip placing of the trays), support for trays: 46.5 cm x 13 cm

item	l x w x h in cm
8013	46.5x54.5x30



glass tray

glass, dark grey, rectangular

item	l x w x h in cm
5161.31	31x21x3.5
5161.62	62x21x3.5



glass tray

glass, satined, rectangular

item	l x w x h in cm
5160.31	31x21x3.5
5160.62	62x21x3.5



base tray "Modul"

melamine, black, surface matt, food-safe, dishwasher-safe, not suitable for microwave and combi steam oven

item	l x w x h in cm	PU
4582	72.5x28x1.8	2 pcs



buffet platter

hardened glass, grey transparent, rectangular, irregularly coloured in a cloudy look, underside structured, dishwasher-safe, scratch-proof

item	l x w in cm	strength in mm
8008.08	80x21	8



buffet platter

special hardened safety glass, 4 mm thick, rectangular, rounded edges, polished rim, dishwasher-safe, rubber feet included (adhesive), underside scratch-proof

item	version	l x w in cm
1668.08	black glass	80x21
1670.08	white glass	80x21



buffet platter

laminated plastic, 8 mm thick, rectangular, black intermediate ply, break-proof, dishwasher-safe, antistatic, deburred edges, rounded corners

item	version	l x w in cm
8007.08	rusted look	80x21
8006.08	dark grey	80x21



tray

massive stainless steel 18/10, rectangular, hammered finish, six times polished, for buffet etagere items 2193, 2193.02 and 8013

item	l x w x h in cm
2193.01	62x18x5



buffet platter

hardened glass, 10 mm thick, rectangular, edges polished and deburred

item	version	l x w in cm
5243	transparent glass	80x21
5243.M	satined glass	80x21



base tray "Modul"

walnut, food-safe sealed, not dishwasher-safe, stackable

item	l x w x h in cm
4722	70x25.5x3.1



etagere "Falcon"

massive stainless steel 18/10, highly polished, dishwasher-safe, food-safe, anti-slip silicone sleeves for use with buffet platters included

item	l x w x h in cm
8086	24x20x45



coup plate "Catering"

china, matt black, round, flat

item	Ø in cm	PU
3954.235	23	12 pcs



plate "Rough!"

china, matt black, round, structured surface

item	Ø in cm	PU
4567.24	24	4 pcs



coup plate "Catering"

china, white, round, flat

item	Ø in cm	PU
3954.21	21	12 pcs



buffet platter, laminated plastic

laminated plastic, 8 mm thick, dark grey, black intermediate ply, break-proof, scratch-proof, dishwasher-safe, antistatic, deburred edges, rounded corners

item	version	l x w in cm
8006.08	rectangular	80x21
8006.14	rectangular	91x21
8006.15	rectangular	102x21

NEW



buffet platter, black glass

special hardened safety glass, 4 mm thick, black, rounded edges, polished rim, dishwasher-safe, rubber feet included (adhesive), underside scratch-proof

item	version	l x w in cm
1668.08	rectangular	80x21
1668.22	rectangular	91x21
1668.24	rectangular	102x21



Anti-slip sleeves provide a safe positioning of buffet platters.



"Falcon" - really detached!

This etagere, inspired by the elegance of a falcon, is giving wings to the creativity at the buffet. A single one can bear up to three plates on its wings or, when used as a duo, fitting buffet platters or a combination of both can be installed. Anti-slip supports can be plugged on if needed and thus provide a safe positioning of the platters.

As a high-tea stand, the etagere carries plain white coup plates or matt-black plates with a slate-like structure. Those plates fit exactly into the slots of the wings.

The mirror polished, solid stainless steel (3 mm) punctuates the precious impression of the dynamic shape, incorporated handrails facilitate the service. This majestic creature is sitting on a stylised branch, which also provides a firm stand.

More buffet platters made of laminated plastic and glass are available as of page 52.

"Shine", page 68



"Splash", page 69



"Reef", page 70 to 73



"Fakir", "Roots", "Matrix", page 74 to 75



"Capiz", page 76



"Unique", page 77



XXL Bowl, page 79



"Cave", page 82



"Duplex", page 82



"Medusa", page 87



"Art de Buffet", page 88 to 93



"Solid", page 112 to 125



Buffet bowls



Thermo bowls "Shine"



The stainless steel bowls of the "Shine" series are double-walled and therefore have an isolating effect. This helps to prevent water condensation - even at higher temperatures. Cold food stays cold and warm food stays warm longer.



The slim top edge appears elegant and filigree. The accentuated contrast between the highly polished outside and the unobtrusive finish on the inside (fine brushed stainless steel, ivory or taupe coloured) makes that series an eye-catcher. "Shine" is the perfect combination of elegance and subtlety. It is easily changeable to achieve a variation of presentations and it is effective due to its double-walled construction.



bowl "Shine"

stainless steel 18/10, outside polished, inside satined, double-walled, round/oblique, dishwasher-safe

item	Ø in cm	height in cm	content in l
2260.16	15.7	6.7/8.8	0.5
2260.20	19.7	8.5/11	0.9
2260.24	23.7	10/13	1.6



bowl "Shine"

stainless steel 18/10, outside polished, double-walled, round/oblique, food-safe coating inside (colour: ivory, not dishwasher-safe)

item	Ø in cm	height in cm	content in l
2261.16	15.7	6.7/8.8	0.5
2261.20	19.7	8.5/11	0.9
2261.24	23.7	10/13	1.6



bowl "Shine"

stainless steel 18/10, outside polished, double-walled, round/oblique, food-safe coating inside (colour: taupe, not dishwasher-safe)

item	Ø in cm	height in cm	content in l
2262.16	15.7	6.7/8.8	0.5
2262.20	19.7	8.5/11	0.9
2262.24	23.7	10/13	1.6

Please note:



When cleaning the coated bowls (ivory and taupe coloured) in the dishwasher, the coating at the rim might abrade in the course of time. Therefore it is recommended to clean these items by hand.

"Splash"



The "Splash" - effect

Dynamics of movement - solidified to a statue! The bowls of the "Splash" series spread a very special flair by their playful optics. Whether used as fruit bowl in the big, for amuse gueule, culinary delights in the small or as decorative deposit place in all varieties, "Splash" sets a charming course at the table and for interiors. The bowls are made of solid pewter, manually assembled of numerous single components and elaborately refined. Knobbed feet at the bottom side guarantee a safe stand.



bowl "Splash"

pewter, hammered finish, polished, round, flat, food-safe, not dishwasher-safe, with supporting feet

item	Ø/height in cm	inside usable area Ø in cm
2340.15	15/5	6
2340.22	22.5/5.5	13
2340.28	28/6.5	19
2340.38	38/8	29

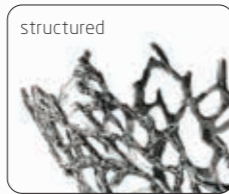

bowl/basket "Reef"
pewter, structured and patinated outside, oval, food-safe, not dishwasher-safe

item	l x w x h in cm
2332	20x10x12



bowl/basket "Reef"
pewter, structured and patinated outside, food-safe, not dishwasher-safe, with supporting feet

item	w x d x h in cm
2335	54x18x66

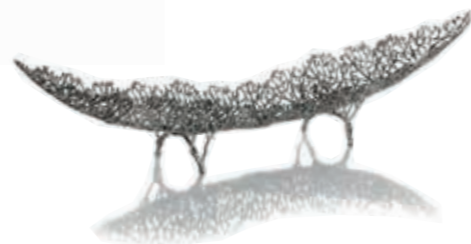

bowl/basket "Reef"
pewter, structured and patinated outside, food-safe, not dishwasher-safe, with supporting feet

item	l x w x h in cm
2336	75x10x14



bowl/basket "Reef"
pewter, structured and patinated outside, food-safe, not dishwasher-safe, with supporting feet

item	l x w x h in cm
2337	100x24x30



bowl/basket "Reef"
pewter, surface smooth, food-safe, not dishwasher-safe, with feet

item	l x w x h in cm
2314.02	approx. 21x12.5x33
2314.03	approx. 37x18.5x52



bowl/basket "Reef"
pewter, smooth outside, oval, food-safe, not dishwasher-safe

item	l x w x h in cm
2313.01	46x19x20
2313.02	32x13x13



wind light
borosilicate glass, satined inside, open at the top and the bottom, for glass insert item 4991.02 and candles up to Ø 7 cm

item	Ø in cm	height in cm	PU
4991.02	9	14.5	6 pcs



candle holder/wind light "Reef"
pewter, surface smooth, food-safe, not dishwasher-safe, with feet, for glass insert item 4991.02 and candles up to Ø 7 cm

item	Ø in cm	height in cm
2315.01	10	15.5



Large numbers of single parts are casted from premium pewter and subsequently assembled in high-grade craftsmanship to give shape to these items. The inimitable pieces of art created that way are unique items, which inspire by the polished surface of the organic structures and the rounded tails of the meshwork. The products of the "Reef" series are genuine gems of dining culture! Whether there are bowls filled with bread or fruit in the focus of attention, high-quality textiles, held together by extravagant napkin rings emphasising the ambiance, or the delightful shadow play of candlelight, creating an atmospheric ambiance – "Reef" turns any table into a fine dining experience.

In the lobby or at the reception desk, which are both a hotel's hallmark, these impressive bowls guarantee lasting impressions with guests and visitors, especially when decorated with blossoms or flower bouquets.

The outside texture of the bowls differs within the series: whether smoothly rounded (page 71 to 73) or roughly structured with dark, patinated deepening (page 70) – each variant has its own charm.



The projecting XXL bowl combines filigree structures with impressive dimensions. Made of premium pewter, countless fine ramifications combine to a beautifully designed whole and thus provide necessary stability with low weight at the same time.

This design gives an unobstructed view of the contents of the bowl and forms a precious frame to stage particularly fruit or other delicacies in an extravagant way. The surface of the bowl is polished on the inside, while on the outside it impresses with its coral-like structure.



"Reef"



The glass platter is available on page 54, the series "Flex" on page 212.



napkin ring "Reef"

pewter, real gold coated (18 ct), surface smooth, food-safe, not dishwasher-safe

item	Ø in cm	length in cm	PU
2317G	5,5x3,5	7,5	2 pcs



napkin ring "Reef"

pewter, surface smooth, food-safe, not dishwasher-safe

item	Ø in cm	length in cm	PU
2317	5,5x3,5	7,5	2 pcs



glass bowl

borosilicate glass, handblown, round, for bowl/basket "Reef" item 2318

item	Ø / height in cm	content in l	PU
4930	7/5	0,14	24 pcs



bowl/basket "Reef"

pewter, smooth outside, round, food-safe, not dishwasher-safe, with supporting feet, for small glass bowl item 4930 (please order separately)

item	Ø in cm	height in cm	PU
2318	8	5	2 pcs



bowl/basket "Reef"

pewter, smooth outside, round, flat, food-safe, not dishwasher-safe

item	Ø in cm	height in cm
2311	22	5



The bowl "Splash" is available on page 69.

NEW

bowl/basket "Reef"

pewter, smooth outside, round, food-safe, not dishwasher-safe, with supporting feet, for glass bowl item 4814.17 and 4814.23/30 (please order separately)

item	Ø in cm	height in cm	suitable to
2320	16	5,5	item 4814.17
2322	22	9,5	item 4814.23/30



glass bowl

dark grey, round, handblown, ground edge, suitable for bowl/basket "Reef" items 2320 and 2322

item	Ø / height in cm	content in l	suitable to
4814.17	17/5,5	0,3	item 2320
4814.23	23/9,5	1,5	item 2322
4814.30	30/13	3,25	item 2322



bowl/basket "Reef"

pewter, smooth outside, round, food-safe, not dishwasher-safe, with supporting feet, for small glass bowl item 5166 (please order separately)

item	Ø in cm	height in cm
2310	13	8



glass bowl

glass, 6 mm thick, dark grey, organically shaped, for bowl/basket "Reef" item 2310 (please order separately)

item	Ø / height in cm	content in l	PU
5166	13/6,5	approx. 0,3	2 pcs

Showpieces of table culture - "Reef"



Please note:



Since medieval times, pewter has been used primarily for table top items and has been the most important raw material for a very long time. The popularity of pewter first started decreasing in the 18th and 19th century by the progressing development of glass and the increasing popularity of porcelain. Since then the usage of pewter has shifted mainly to decorative elements. Up-to-date pewter is 100 % lead-free and therefore uncritical when used for food.



"Matrix"



bowl "Matrix"

brass, top golden (transparent coating, food-safe), bottom dark patinated, hexagonal, flat, not dishwasher-safe

item	Ø in cm	height in cm
2382.38	38	7



bowl "Roots"

brass, golden (transparent coating, food-safe), round, not dishwasher-safe

item	Ø in cm	height in cm
2381.38	38	8



bowl/display "Fakir"

brass, inside golden (transparent coating, food-safe), outside dark patinated, not dishwasher-safe

item	Ø in cm	height in cm
2380.07	7.5	11
2380.12	12.5	10
2380.15	15	8.5
2380.18	18	9.5



coaster/glass insert

clear glass, 4 mm thick, edges polished and deburred, with 4 transparent rubber feet

item	Ø in cm	PU
5244.11	11	6 pcs
5244	13	6 pcs
5244.17	16.7	1 pc
5244.21	20.7	1 pc
5244.24	24.2	1 pc
5244.28	28.2	1 pc

The silicone feet may be attached if needed.

"Roots, Matrix & Fakir" – Brass all of a piece!

Massive brass, produced in traditional sand casting, creates unique sculptural items, which enthuse especially by their contrast between matt golden surfaces and dark patination. Opposing in form and shape but still belonging together, the bowls "Roots" and "Matrix" as well as the exceptional displays of the "Fakir" series, add up to a harmonic overall composition.

The bowls "Roots", a tight web of rootlike structures, and "Matrix", strictly geometrically constructed of hexagons, could hardly be more opposing. Especially this aspect makes the combination of the two so interesting. Besides the presentation of bread and fruit on the buffet, these bowls fascinate as sculptures or decorative elements as well. An interesting add-on to the "Fakir" bowls are round glass platters of the Zieher product range. These can be laid on easily and thus generate the option to use the impressive objects on both sides.

All items are golden-coloured and partially dark patinated, further discolouration or oxidation is prevented reliably by the food-safe sealing of the golden parts.



"Fakir"



The buffet stands of the "Somnia" series are available on page 14.

Please note:



The items made of brass are suitable for cold/dry food only. Not dishwasher-safe.

"Fakir"



"Capiz"



The rechargeable LED-light item 8150 is available on page 49.

Ivory-coloured clamshells with a nacreous gloss grant these products their special appeal. In combination with crushed ice and the Zieher rechargeable LED-lights, the double-walled bowls produced in mosaic-look create fascinating effects, thus becoming the eye-catcher at the buffet. The double-walled construction provides insulating characteristics. This prevents the formation of condensation on the outside of the bowls to the greatest possible extent.



Separates ice and melt water

charger plate, white glass

special hardened safety glass, 4 mm thick, white, edge polished, dishwasher-safe, with rubber feet (adhesive), underside scratch-proof

item	Ø in cm
1671.33	33



bowl "Capiz"

shell, ivory-coloured, double-walled, round, rim approx. 2 cm wide, resin-coated, not dishwasher-safe

item	Ø in cm	height in cm
7109.46	46	23

Please note:



Suitable for cold and dry food, not dishwasher-safe.

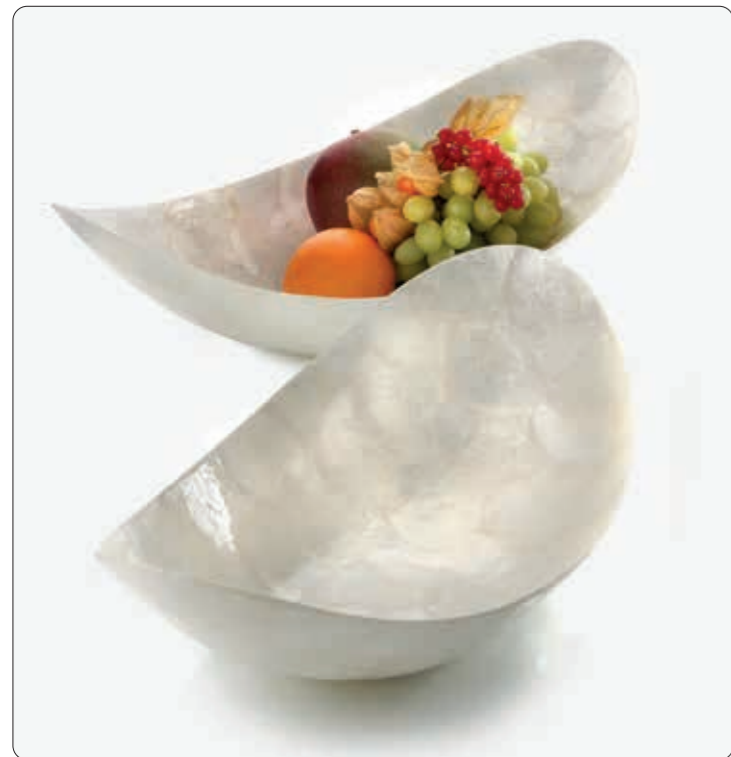

bowl "Capiz"

shell, ivory-coloured, double-walled, round, with slightly cone-shaped bottom, rim approx. 3 cm wide, resin-coated, not dishwasher-safe

item	Ø in cm	height in cm
7112.36	36	17.5

bowl "Capiz"

shell, ivory-coloured, oval, resin-coated, not dishwasher-safe

item	l x w x h in cm
7106.46	46.5x24x13.5

"Unique"



The etagere "DressCoat" is available on page 94, the total series "Unique" on page 164.



glass bowl "Unique"

glass, white marbled, outside satined, round

item	Ø / height in cm	content in l	PU
5182.16	16/5	approx. 0.67	6 pcs
5182.21	21/8	approx. 2.0	4 pcs
5182.27	26.5/8	approx. 2.75	4 pcs



bowl

clear glass, white, handblown, wavy, with clear rim

item	Ø in cm	height in cm
4810.01	approx. 38-40	approx. 9.5
4810.02	approx. 50-52	approx. 14

Please note:



Due to the complex production process, small air inclusions in the glass are inevitable.

Manufactured in old tradition!



Each of these high grade bowls is unique and almost completely handcrafted. At this, coloured glass is completely covered with crystal clear glass. This process awards the bowls with top brilliance and an impressive look. The handblown glass blank is modelled manually, whereby unique pieces are created which excite by their organic shape.

Platters and bowls made of grey glass



The gold-plated napkin ring "Reef" is available on page 72.

The buffet crosses "StiXXX" made of laminated plastic are available on page 41.

glass platter/tray

glass, structured, dark grey, rectangular, with handles

item	version	l x w x h in cm	PU
5021.01	1/1 GN	53x32.5x2	3 pcs
5021.02	1/2 GN	32.5x26.5x2	4 pcs
5021.03	2/4 GN	53x16x2	4 pcs



buffet bowl

glass, 8 mm thick, dark grey, oval, structured, delivery in strong wooden box

item	l x w x h in cm
5176	130x42x8



The buffet stands "Crossline" are available on page 17.

glass bowl

glass, 6 mm thick, dark grey, oval, structured

item	l x w x h in cm
5175.41	41x19.5x5.5
5175.44	44.5x25x6

XXL-bowl made of grey glass



The rechargeable LED-light item 8150 is available on page 49, further variations of the "Crossline" buffet stands are available on page 16.

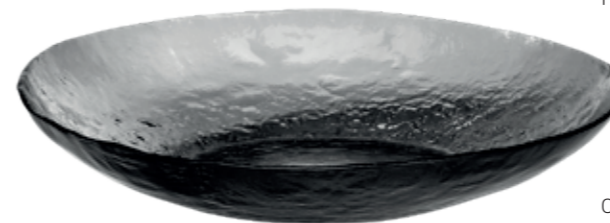

buffet bowl

glass, 8 mm thick, dark grey, round, structured, delivery in strengthened carton

item	Ø in cm	height in cm
5704	82	15

This monumental bowl made of dark grey glass arches like a sculpture and melts optically with crushed ice to stage classy seafood or champagne in an opulent way.

In combination with the Zieher rechargeable LEDs, which perfectly accentuate the irregular structure of the glass, the presentation becomes even more dramatic! This effect is further intensified by the optical refraction of the ice.

This impressive bowl with a diameter of 82 cm can be placed free-standing on the floor by using the fitting rack (item 8213). But also right at the buffet table or arranged together with the stands of the "Crossline" series in different heights - these designer pieces know how to impress.



rack for XXL bowls

steel, matt black (powder-coated), three-part for self assembly, adjustable feet for firm positioning on most surfaces, for XXL bowl "Konkret!" item 8212.D and XXL glass bowl item 5704

item	l x w x h in cm
8213	70x70x57



buffet stand "Crossline"

galvanised steel, matt black (powder coating), square, hinged beams on top

item	l x w x h in cm	l x w in cm (on top)
8320.15	41.5x41.5x15.5	34x34
8320.31	49.5x49.5x31	34x34





glass tray

glass, dark grey, rectangular

item	l x w x h in cm
5161.31	31x21x3.5
5161.62	62x21x3.5



glass tray

glass, satined, rectangular

item	l x w x h in cm
5160.31	31x21x3.5
5160.62	62x21x3.5



buffet bowl

glass, transparent, wide rim, structured

item	Ø in cm	height in cm
5049.35	35	6

buffet bowl

glass, transparent, wide rim, structured

item	Ø in cm	height in cm
5024.45	45	11

buffet bowl

glass, satined, concentric shape with steps

item	Ø in cm	height in cm
5013.46	46	5.5



glass platter

glass, structured, transparent, square

item	l x w in cm
5063	30x30
5063.50	50x50



buffet bowl

glass, satined, square

item	l x w in cm
5014.38	38x38



The buffet displays "Classy" are available on page 36 and 37.



buffet bowl

glass, 8 mm thick, dark grey, oblong, structured

item	l x w x h in cm
5703	96x29x10



glass plate

glass, 8 mm thick, dark grey, rectangular, with the structure of tree bark

item	l x w in cm	PU
5702	40x22	2 pcs



glass plate

glass, 8 mm thick, dark grey, oval, with the structure of tree bark

item	l x w in cm	PU
5700	33x24	3 pcs



glass bowl

glass, 8 mm thick, dark grey, oval, with the structure of tree bark

item	l x w x h in cm	PU
5701	26.5x19.5x4.5	3 pcs



"Cave"



The glass version of the "Cave" bowl is available in two sizes. The soft tinge of this grey glass, which is manufactured in a traditional hand-blowing process, at first glance allows an unobstructed view onto the content of these shapely objects. They offer the fitting framework for fruit, nuts and nibbles as well as for tastefully arranged pasta or salad on a solemnly decorated table. The content of the bowls remains protected by the shell of glass, the amply dimensioned opening seduces to snap at a chance. These unique items also enthuse as a place to keep all kinds of accessories. "Cave" in a smaller version, made of china, is available on page 163.



glass bowl "Cave"

dark grey, round, handblown

item	Ø in cm	opening Ø in cm	height in cm
4815.18	approx. 18	approx. 14	approx. 11.5
4815.24	approx. 24	approx. 19	approx. 16.5

"Duplex"

The solid coloured grey glass of these unique handblown pieces serves as an unobtrusive background and suitable framework for perfectly arranged dishes. The bowls can be used on both sides. A soft recess is formed when the closed side is up for ambitious dishes. By using it upside down, there will be more capacity, which is ideal e. g. to fill in crushed ice.



Useable on both sides!



The rechargeable LED-light item 8150 is available on page 49.



glass bowl "Duplex"

dark grey, round, bottom side open, useable on both sides

item	Ø in cm	height in cm
4813.28	28	6.5
4813.35	35	7.5
4813.46	46	10



We recommend the use of silicone ring 4681.S with the smallest bowl item 4814.17

Please note:

All items shown on this pages are hand-blown. Therefore it is impossible to avoid variations in glass thickness, colour intensity and weight.

The handblown bowls made of grey-tinted glass are deliberately restrained in their design, yet they have been shaped to exhibit high versatility in their appearance.

The combination of the bowls with the gold-coloured stands of the "Somnia" series (page 14) creates an opulent and extravagant buffet staging, which is fascinating purely by its appearance. The subtle grey tinting of the glass bowls also matches perfectly with the matt black surface of the optionally available silicone rings, which form a non-slip basis and increase stability.



glass bowl

dark grey, round, handblown, ground edge

item	Ø in cm	height in cm	content in l
4814.17	17	5.5	approx. 0.3
4814.23	23	9.5	approx. 1.5
4814.30	30	13	approx. 3.25
4814.40	40	10	approx. 4.5



ring "SelectionA."

silicone, Ø 8.3cm, for glass bowl item 4814.17

item	colour	PU
4681.S	black	6 pcs



The buffet stands "Somnia" are available on pages 14 und 15.



stand/ring, illuminatable

silicone, black, Ø 15.2 cm, usable as an optional stand, for glass bowls item 4814.23 and 4814.30, suitable for rechargeable LED-light item 8150

item	Ø in cm	height in cm
4679.S	15.2	5.5



ring „SelectionA.“

silicone, Ø 13.4 cm, for glass bowls item 4814.23 and 4814.30

item	colour	PU
4682.S	black	3 pcs
4682.W	white	3 pcs



The trays and bowls of the "Artisan" series are fascinating and diversified at the same time. The inside with its perfectly polished surface creates an interesting contrast to the matt outside.

The handcrafted rim impresses by its irregularity and is crowned by a circumferential brass edge. The combination of hammered and plain surfaces, of massive stainless steel and brass, awards this series with that certain something.

"Artisan" is a series of contrast



The plane surface of the trays facilitates the service and prevents unpleasant noise. When used at the buffet, arranged food can be presented in an appealing way and is accentuated by the reflection of the polished surfaces.



Please note:  When cleaning in the dishwasher, the brass rim may change its colour in the course of time. Therefore it is recommended to clean these items by hand.



bowl "Artisan"
stainless steel 18/10, inside polished, outside matt finish, round, hammered rim with golden adornment (brass)

item	Ø in cm	height in cm	content in l
2371.07	7.5	3.5	approx.0.1
2371.11	11	5.5	approx.0.3
2371.14	14.5	7	approx.0.7
2371.16	16.5	8	approx.1.0
2371.21	21.5	9	approx.2.0



tray "Artisan"
stainless steel 18/10, inside polished, outside matt finish, oval, hammered rim with golden adornment (brass), utility space smooth finish

item	l x w in cm	height in cm
2374.24	24.5x15	approx.1.5



tray "Artisan"
stainless steel 18/10, inside polished, outside matt finish, round, hammered rim with golden adornment (brass), utility space smooth finish

item	Ø in cm	height in cm
2370.23	23	approx.2.5
2370.28	28	approx.3
2370.33	33	approx.3

etagere "Artisan"
stainless steel 18/10, inside polished, outside matt finish, round, not dishwasher-safe, hammered rim with golden adornment (brass), with brass handle, demountable, with 3 rubber feet

item	Ø in cm	height in cm
2376	33/28/23	45

bread/pastry bowl "Artisan"
stainless steel 18/10, inside polished, outside matt finish, oval, flat, hammered rim with golden adornment (brass), bottom smooth finish

item	l x w x h in cm
2372	22x15x3.5

bread/pastry bowl "Artisan"
stainless steel 18/10, inside polished, outside matt finish, oval, high, hammered rim with golden adornment (brass), bottom smooth finish

item	l x w x h in cm
2373	22x13x7

Stainless steel - refined!



All information concerning refinement of glass and china are available on pages 146 and 300.



We gladly offer you buffet displays, bread baskets or cruet stands etc. with different surfaces. This option is feasible for almost all products made of stainless steel. Highly polished as well as matt stainless steel can be finished in golden, copper or black colour using the PVD process. Price, minimum order quantity and delivery time upon request.

Please ask us, we will gladly prepare an individual offer for you.



black



copper

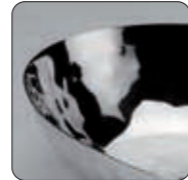

stainless steel, polished



golden

Advantages of the PVD coating:

- Food-safe
- Dishwasher-safe
- Better strength and adherence compared to galvanic refinement
- Brilliant colouring, colourfast and resistant against UV radiation

All items made of stainless steel can be powder-coated in all current RAL colours upon request. In contrast to PVD refining, this coating is not dishwasher-safe.

We will be delighted to advise you!

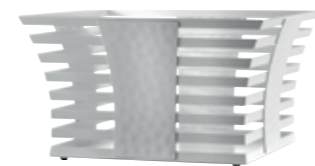

"Medusa"



"Medusa" - risen from the deep-sea

These organically shaped bowls appear like creatures of the sea which float silently through the depth of the ocean. Even if the tentacles, modelled in numerous processing steps, appear very filigree, they still provide a safe base. Despite the solid stainless steel, these hammered bowls award a natural airiness and an almost floating impression.

"Medusa" offers the perfect setting for all sorts of seafood or extravagantly presented salads and desserts. Even as a decorative storage space, these bowls cut a good figure.



bowl "Medusa"

massive stainless steel 18/10, organically shaped, hammered finish, polished

item	l x w x h in cm
2120.15	15.5x15.5x14
2120.25	25.5x25x16.5
2120.38	38x38x23





bowl "Wings"
massive stainless steel 18/10, hammered finish, six times polished

item	l x w x h in cm
2169	approx. 34x22x48
2169.01	approx. 21x12.5x30.5
2169.02	approx. 15.5x9x19



etagere
massive stainless steel 18/10, round, hammered finish, six times polished, with stainless steel feet, not demountable

item	Ø in cm	height in cm
2197	50/40/30	33



Please note:
The baseplate has to be mounted!

bowl "Loop"
massive stainless steel 18/10, oval, hammered finish, six times polished, with black marble foot

item	l x w x h in cm
2109	approx. 39x19x67



bowl "Sixth Sense"
massive stainless steel 18/10, hammered finish, six times polished, with stainless steel feet

item	l x w x h in cm
2171	approx. 48x25x74
2171.01	approx. 37x17.5x54
2171.02	approx. 20x12x34

The exceptional design of the "Art de Buffet" series acts as an eye-catcher at both modern and elegantly traditional buffets. It presents artistically arranged dishes in a favourable way. Every piece of this series is made of massive stainless steel 18/10, has a hand-made hammered finish and is six times hand-polished



The XXL bowl item 2170 is available on page 93.



Buffet bowls

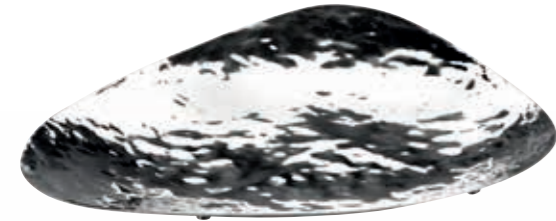

bread/pastry bowl
massive stainless steel 18/10, hammered finish, six times polished

item	l x w x h in cm
2121.22	24x15x8

bowl flat
massive stainless steel 18/10, hammered, polished

item	l x w x h in cm
2206.50	50x40x6.5
2206.60	60x46x7.5



bowl
massive stainless steel 18/10, oblong, hammered finish, six times polished

item	l x w x h in cm
2116.41	41x15.5x6.5

bowl
massive stainless steel 18/10, round, high, hammered finish, six times polished

item	Ø in cm	height in cm	content in l
2181.14	14	7.5	1.0



bowl
massive stainless steel 18/10, round, hammered finish, six times polished

item	Ø in cm	height in cm	content in l
2181.17	17	6.5	1.1
2181.21	21	8	2.0
2181.24	24	9.5	3.25



etagere
massive stainless steel 18/10, triangular, smooth finish, six times polished, not demountable

item	Ø in cm	height in cm
2187	13	16.5



bowl
massive stainless steel 18/10, triangular, smooth finish, six times polished

item	Ø in cm	height in cm	content in l
2182.09	9	4	0.08
2182.13	13	6	0.28
2182.22	22	10.5	1.25
2182.30	30	12	3.0



bowl
massive stainless steel 18/10, triangular, hammered finish, six times polished

item	Ø in cm	height in cm	content in l
2180.09	9	4	0.08
2180.13	13	6	0.28
2180.22	22	10.5	1.25
2180.30	30	12	3.0
2180.40	40	16	7.0

"Art de Buffet"



The glass bowls are available page 80.



buffet stand

massive stainless steel 18/10, highly polished

item	Ø in cm	height in cm
2141.01	25/20	13
2141.02	27/22	17.5
2141.03	29/25	23

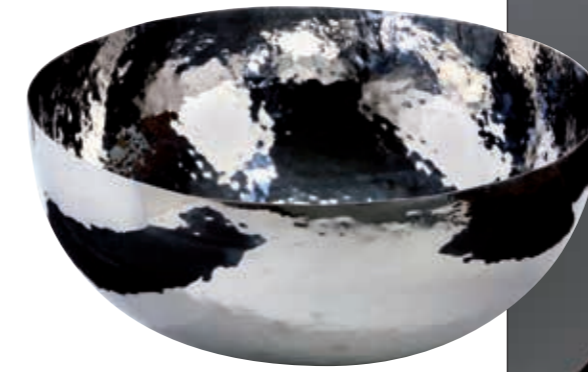

bowl/basin XXL

massive stainless steel 18/10, round, hammered finish, six times polished

item	Ø in cm	height in cm	content in l
2170	70	30	85.0



2170 + 5240.M
Separates ice and meltwater



"Art de Buffet"



2174 + 2141.01

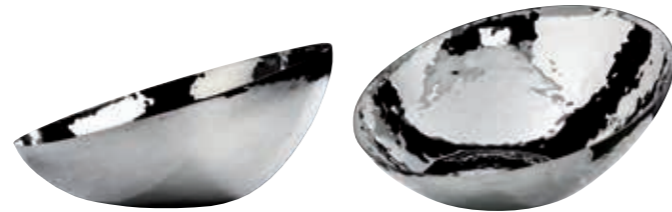

bowl

massive stainless steel 18/10, oblique, hammered finish, six times polished

item	Ø in cm	height in cm
2174	38	7/15



buffet platter/separating plate

hardened glass, 10 mm thick, satined, round, reduces useable capacity of XXL bowl to approx. 40 l content (15 cm useable depth)

item	Ø in cm
5240.M	60



hand pump

highly elastic PVC, 2.5 mm thick, with hose, for easy drainage of melt water, professional quality, vacuum capacity: 10 l/min

item	Ø hose in cm	total length hose in cm
5662	2	250

The waterproof LED-light item 8150 is available on page 49.



buffet bowl

massive stainless steel 18/10, oblong, hammered finish, six times polished

item	l x w x h in cm
2184	62x15x7



buffet bowl

massive stainless steel 18/10, square, hammered finish, six times polished, with horn-ball feet

item	l x w x h in cm
2132	31x31x17



champagner bowl

massive stainless steel 18/10, hammered finish, six times polished

item	Ø in cm	height in cm	content in l
2163	39	19	18.0



buffet bowl

glass, transparent, wide rim, structured

item	Ø in cm	height in cm
5024.45	45	11



2163 + 5024.45

It is recommended to clean the horn-ball feet only with moist, soft tissues and non-abrasive substances. Cleaning in the dishwasher may damage the sealing.

Etagere "DressCoat"



Food: Pâtisserie Walter
www.patisserie.de

The etagere with three tiers, made of hammered and highly polished stainless steel, forms an extravagant basis for many sorts of plates and platters. The supporting rings with a diameter of 15 cm offer the possibility to insert not only plates and platters, but alternatively also bowls. Small black silicone rings keep inserted porcelain in position and prevent annoying clattering.

A very special aesthetic setup can be arranged by using a combination of several etageres along with the biggest plate of the "DressCoat" series (page 156). Numerous presentation areas on a total of four different levels can be created by placing additional plates directly on the table. The diameter of 22 cm is more than sufficient to put different pralines, petit fours and other creations of confectionery into the limelight in an impressive way. In connection with the almost invisible tier stands, the porcelain tablecloths appear amazingly airy and playful by their floating look-and-feel. A buffet presentation with an elegant vibrancy, caused by the drapery of the "DressCoat" plates - that's where it comes into its own.



etagere "DressCoat"
massive stainless steel 18/10, hammered, polished, 3-armed

item	Ø in cm	height in cm
2212.30	36	30



plateau plate "DressCoat"
white china, useable area (plateau): Ø 19.5 cm, also useable as a bowl

item	Ø / height in cm	content in l	PU
4388	22/6.5	0.9	3 pcs



glass plate "Unique"
glass, white marbled, bottom satined, round

item	Ø in cm	PU
5178.21	21	6 pcs
5178.28	28	6 pcs

Please note:



We recommend the use of large plates on the lower level only.

Even in the hotel room, the etageres can be positioned in an eye-catching way. Equipped with "DressCoat" or other tableware, small snacks, a selection of fruit or a sweet welcoming treat can be staged in an appealing way.



The entire series "DressCoat" is available on page 156, the series "Unique" on page 164.

Etageres



"Flower-Tree"

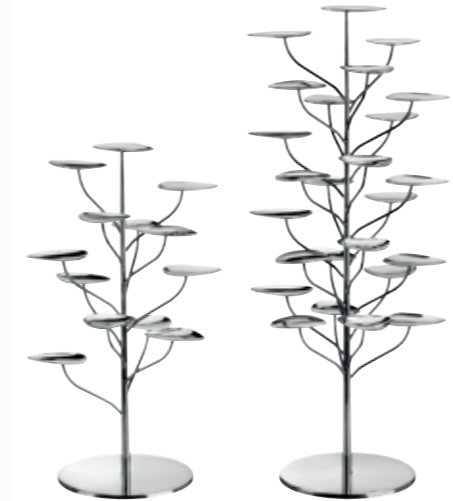

etagere "Flower-Tree"

massive stainless steel 18/10, smooth finish, polished, Ø29 cm, with miniature plates (approx. 9 cm x 7.5 cm)

item	height in cm	number of levels
2208.13	51.5	13
2208.25	71	25

The "Flex-Tree" enthruses by its versatility! On these trees, plain discs replace the fixed leaves. With a diameter of 5.5 cm, they offer sufficient space to equip the tree either with glass, porcelain or stainless steel miniatures.

To be on the safe side, they can be placed on black or white anti-slip silicone pads. This reduces the sound emission and at the same time increases the stability of the used miniatures. All trees are made of massive stainless steel and are accurately high gloss polished. The 8 mm thick foot is the perfect base and guarantees a safe stand.



Anti-slip pads made of Silicone are available on page 214.

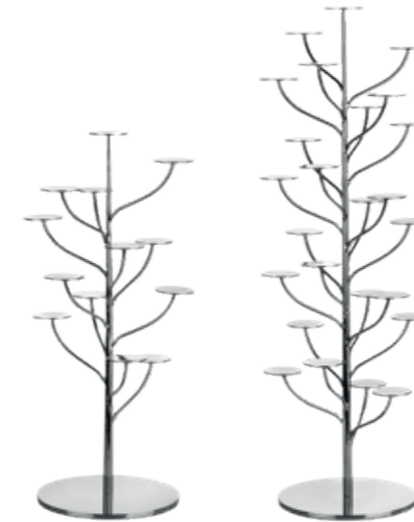

etagere "Flex-Tree"

massive stainless steel 18/10, smooth finish, polished, Ø 24 cm, with round discs (Ø 5.5 cm)

item	height	number of levels
2209.13	53	13
2209.25	72	25



"Flower-Tree" - A tree to dream of!

On 13 resp. 25 levels, these trees offer the possibility to present and showcase finger food, petit-fours and other delicacies. Also a selection of jam in handy jars can be presented in an appealing way as well as fresh apples which, placed on the leaves, invite to take one. These masterpieces of craftsmanship also accentuate the beauty of each lobby by its decorative character.

The shape of the leaves is based on the already existing plateau plates and "Flower-Tower" etageres (page 99 and 100). Especially on the buffet, this opens up the option to arrange the buffet installations diversified, but nevertheless harmoniously and variable.



The plateau plates are available on page 100.



plateau plate "DressCoat"

china, white, also useable as a bowl

item	Ø / height in cm	content in l	PU
4386.01	9/4.5	0.1	12 pcs

miniature plate

china, round, flat, Ø10.5 cm

item	colour	PU
4606.10	white, glossy	12 pcs
4607.10	black, matt	12 pcs



glass miniature plate

glass, 4 mm thick, green, structured, leaf shape

item	l x w in cm	PU
5037	14x7.5	12 pcs

"Table-Tree" NEW



etagere "Table-Tree" Flower

massive stainless steel 18/10, smooth finish, polished, Ø29 cm, with miniature plates (approx. 9 cm x 7.5 cm)

item	Ø in cm	height in cm	number of levels
2208.06	29	30	6



The cloche (item 4852) and a suitable saucer made of walnut wood (item. 4734.03) are available on page 179.



etagere "Table-Tree" Pin

massive stainless steel 18/10, smooth finish, polished, Ø15 cm, with skewers and stoppers

item	Ø in cm	height in cm	number of levels
2210.06	15	30	6



etagere with 1 tier

massive stainless steel 18/10, hammered, polished, 7 miniature plates (approx. 9 cm x 8 cm)

item	Ø in cm	height in cm
2202	25	9



etagere with 3 tiers

massive stainless steel 18/10, hammered, polished, 21 miniature plates (approx. 9 cm x 8 cm)

item	Ø in cm	height in cm
2201	25	44.5



amuse gueule stand with foot

massive stainless steel 18/10, polished

item	l x w x h in cm
2204.08	11.5x9.5x8.5
2204.11	11.5x9.5x11.5



ice cream cup with foot

massive stainless steel 18/10, hammered, polished

item	l x w x h in cm	content in l
2207.11	11.5x10x11	0.15
2207.15	13.5x11x15	0.25

"Flower Tower"



Design: Itamar Harari

"Table-Tree" - Tempting variety on the buffet

For the presentation of filigree delicacies in the smallest of spaces, the new "Table-Trees" from Zieher offer numerous possibilities for a stylish staging.

The trees can also be used on the buffet and are a beautiful supplement to the larger exemplars of the "Flower-Tree" and „Flex-Tree" family (pages 96/97).

A selection of fruit, chocolates or patisserie can be presented on the six organically shaped petals of the "Table-Tree" Flower. For surprising moments, the "Table-Tree" Pin offers the possibility of presenting finger food or small snacks on six skewers at different heights. Melon with ham, dates wrapped in bacon or tastefully filled parmesan baskets and edible flowers find an attractive place on the elegant branches. Each delicacy is held securely by an artfully shaped spiral and prevented from slipping.

The 30 cm high "Table-Trees" are made entirely of stainless steel by hand and polished to a high gloss.

The solid base forms the basis of these filigree products and ensures a secure stand.



Floral shapes in a steely gloss!

Seemingly organic shapes in an interplay with the gloss and reflections of hammered and polished stainless steel make up the special charm of this product line. Different etageres and plateau plates (page 100) allow a visually harmonious yet flexible and diversified presentation of appetizers or desserts on the buffet.

But also finger food, petit-fours, elaborately decorated cup cakes or a selection of chocolates in the guest room will find a convenient stage on these products. The ice cream/sorbet cups and petit-fours stands in various sizes make a nice complement and individually stage appetizers or a dessert.

The formal base for all products is a slightly arched and kidney-shaped miniature plate.

On three levels, the buffet etagere combines seven small plates each to a presentation platform of floral appearance and offers space to present up to 21 delicacies in a compact and stylish way. The single levels are supported by a filigree trestle made of massive stainless steel, which in shape and construction, deliberately readopts the design of other Zieher etageres. So nothing gets in the way of a harmonic combination of the different product lines.

The table etagere consists of one level only and is therefore perfectly suitable for the restaurant service to present intermediate courses, antipasti or dessert variations. This product is the ideal choice - even as a stylish storage dish for different types of fruit or accessories of daily use.



The massive marble platter with its 24 holes forms a stable base for various uses. Whether coil shaped holders made of porcelain and glass, skewers made of high-gloss polished stainless steel or presentation platforms in different heights – the skewer platter from Zieher offers numerous options to present small delicacies in an appealing way.

More skewers and plates are available on pages 230 and 231. Please note the details of natural stone on page 231.



miniature plate with rod

massive stainless steel 18/10, hammered, polished, plate approx. 9x8 cm, for marble platters 8052 and 8054

item	height in cm
2203.08	8
2203.13	13
2203.18	18
2203.23	23

holder coil shape

massive stainless steel 18/10, hammered finish, six times polished, for inserts made of china and glass

item	Ø in cm	total height in cm
2167.15	5.5	20
2167.20	5.5	25
2167.25	5.5	30
2167.30	5.5	35

skewer

stainless steel 18/10, polished, 24 cm long

item	version	PU
1939.01	Moon	12 pcs
1939.02	Flame	12 pcs

glass miniature

clear glass

item	Ø / height in cm	content in l	PU
5405	5/8.6	0.1	6 pcs

miniature

china, stackable, Ø 5.3 cm, 7 cm high, 0.1 l content

item	colour	PU
4490	white	6 pcs
4490.01	black, matt	6 pcs

glass miniature

borosilicate glass, transparent, handblown, double-walled, with reinforced rim

item	Ø / height in cm	content in l	PU
4901.03	6/7.5	approx. 0.08	6 pcs

Please note:  Positioning of plateaus with same height is only possible to a limited extent.



NEW

plate, slate
natural slate, rectangular, with 3 holes (Ø 5 mm), with 4 feet of felt (not dishwasher-safe), for holder coil shape items 2167... or skewer item 1939... or miniature plates items 2203... (please order separately)

item	l x w x h in cm
8054	30x10x2.5



marble platter
black/brown, polished surface, sides rough-textured, stainless steel feet, 24 holes (Ø 5 mm), for holder coil shape items 2167..., skewer items 1939... or miniature plates items 2203... (please order separately)

item	l x w x h in cm
8052	45x31x5



Design: Itamar Harari



More etageres for china and glass are available on the following pages.



etagere

massive stainless steel 18/10, hammered finish, six times polished, including 3 removable trays item 2110.01 (30 cm long, 8 cm wide, 3 cm high)

item	l x w x h in cm (etagere only)
2110	11.5x11.5x39 (height without handle)



tray

massive stainless steel 18/10, rectangular, hammered finish, six times polished, with feet, for etagere item 2110

item	l x w x h in cm
2110.01	30x8x3



pastry tray

massive stainless steel 18/10, rectangular, hammered finish, six times polished

item	l x w in cm
2136	30x12.5



etagere

massive stainless steel 18/10, hammered finish, polished, with 3 insertion levels (Ø inside: 6.5 cm) for plates/bowls with max. Ø 11 cm

item	l x w x h in cm	levels
2107.03	12.5x11.5x23	3

2107.03 + 4606.10 2107.03 + 4607.10



tray

massive stainless steel 18/10, square, hammered finish, six times polished, with feet

item	l x w x h in cm
2101.17	17.5x17.5x2.3



etagere

massive stainless steel 18/10, hammered finish, polished, with 3 insertion levels (Ø inside: 10.8 cm) for plates/bowls with max. Ø 17.5 cm

item	l x w x h in cm	levels
2105.03	20.5x18x37.5	3



Elegantly served and presented in style - classic plate etageres, newly inspired!

Shapely and individual stands by Zieher are suitable for numerous applications. The classic plate etageres with three levels are available in two sizes. Petit-fours, desserts, chocolates or other delicacies are effectively presented by the classic mini format etageres. The larger version is perfectly suitable for scones and jam during Five O'Clock Tea, but also a choice of cold cuts, cheese or fruit can be staged elaborately on the set table. Matching inserts made of porcelain, glass or stainless steel can be found on pages 254 and 255.



2105.03 + 4607.17



2105.03 + 4606.17



2105.03 + 2101.17



buffet etagere

massive stainless steel 18/10, hammered finish, six times polished, including 5 trays item 2119.01 (66 cm long, 8 cm wide, 3 cm high)

item	w x d x h in cm	PU
2119	66x54x32	1 set (6 parts)



tray

massive stainless steel 18/10, rectangular, hammered finish, six times polished, with feet, for buffet etagere item 2119

item	l x w x h in cm
2119.01	66x8x3



buffet platter

special hardened safety glass, 4 mm thick, rounded edges, polished rim, dishwasher-safe, rubber feet included (adhesive), underside scratch-proof

item	version	l x w in cm
1670.12	white glass	66x10

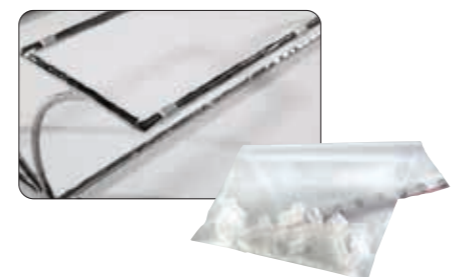

silicone sleeve

transparent, slotted alongside, for buffet etagere item 2119, 2193 and 2193.02 (prevents the slipping of glass platters)

item	length in cm	PU
4683	1	24 pcs

For placement with glass platters, we recommend the use of non-slip silicone sleeves (item 4683).



buffet etagere

massive stainless steel 18/10, hammered finish, six times polished, including 3 trays item 2193.01 (62 cm long, 18 cm wide, 5 cm high)

item	w x d x h in cm	PU
2193	62x42x32.5	1 set (4 parts)

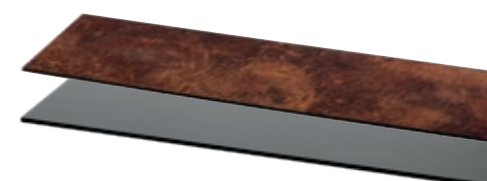

buffet platter

laminated plastic, 8 mm thick, middle layer black, break-proof, dishwasher-safe, antistatic, deburred edges, rounded corners

item	version	l x w in cm
8007.08	rusted look	80x21
8006.08	dark grey	80x21



buffet platter

tempered glass, grey transparent, irregular colouring in cloudy optics, reverse side structured, suitable for dishwashers, scratch resistant

item	l x w in cm	thickness in mm
8008.08	80x21	8



buffet platter

special hardened safety glass, 4 mm thick, rectangular, rounded edges, polished rim, dishwasher-safe, rubber feet included (adhesive), underside scratch-proof

item	version	l x w in cm
1668.08	black glass	80x21
1670.08	white glass	80x21

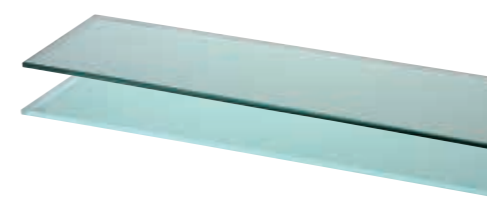

buffet platter

hardened glass, 10 mm thick, rectangular, edges polished and deburred

item	version	l x w in cm
5243	transparent glass	80x21
5243.M	satined glass	80x21



buffet etagere

massive stainless steel 18/10, hammered finish, six times polished, delivery without trays item 2193.01 (please order separately)

item	w x d x h in cm
2193.02	46x42x31



Glass trays are available on page 80.

tray

massive stainless steel 18/10, rectangular, hammered finish, six times polished, for buffet etagere items 2193, 2193.02 and 8013

item	l x w x h in cm
2193.01	62x18x5



The jam trays are available on page 257.

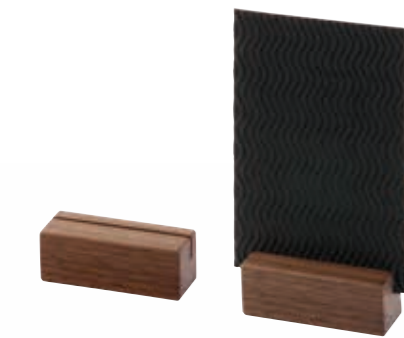

card holder

walnut, varnished, slot 2 mm wide

item	l x w x h in cm	PU
4726	8x3x3	4 pcs

table display

china, white, for self-labeling

item	l x w in cm	PU
4076	8x4.5	6 pcs



The buffet bowls are available on page 168.



toast rack

massive stainless steel 18/10, hammered finish, six times polished, for 4 slices of toast

item	l x w x h in cm
2190	20x8.5x15



ashtray for cigars

optical glass, transparent, also usable as a rest for tongs or spoons, in black gift box

item	l x w x h in cm
5210	15x9x3



card holder

stainless steel 18/10, polished, heavy quality, slot 1 mm wide

item	l x w x h in cm
3461	2.5x2.5x2.5



small glass bowl/spoon rest

glass, 4 mm thick, structured, dark grey, organically shaped, slightly oval form

item	l x w in cm	PU
5172	11x7.5	12 pcs



tongs holder

massive stainless steel 18/10, hammered finish, six times polished, for tongs up to a length of 24 cm

item	l x w x h in cm
2115	27.5x9.5x28



spoon rest

massive stainless steel 18/10, rectangular, hammered finish, six times polished

item	l x w in cm
2154	18x10

Please note:



The tongs have a thickness of 4 mm, they rest perfectly in the hand and convey a sense of quality!



chocolate/ice cube tongs

massive stainless steel 18/10, hammered finish, six times polished, 19 cm long

item	version
2138	stainless steel



serving tongs

massive stainless steel 18/10, hammered finish, six times polished

item	length in cm
2139	28



serving tongs

massive stainless steel 18/10, hammered finish, six times polished, 21.5 cm long

item	version
2140	stainless steel

"Fingerfood-Tree"

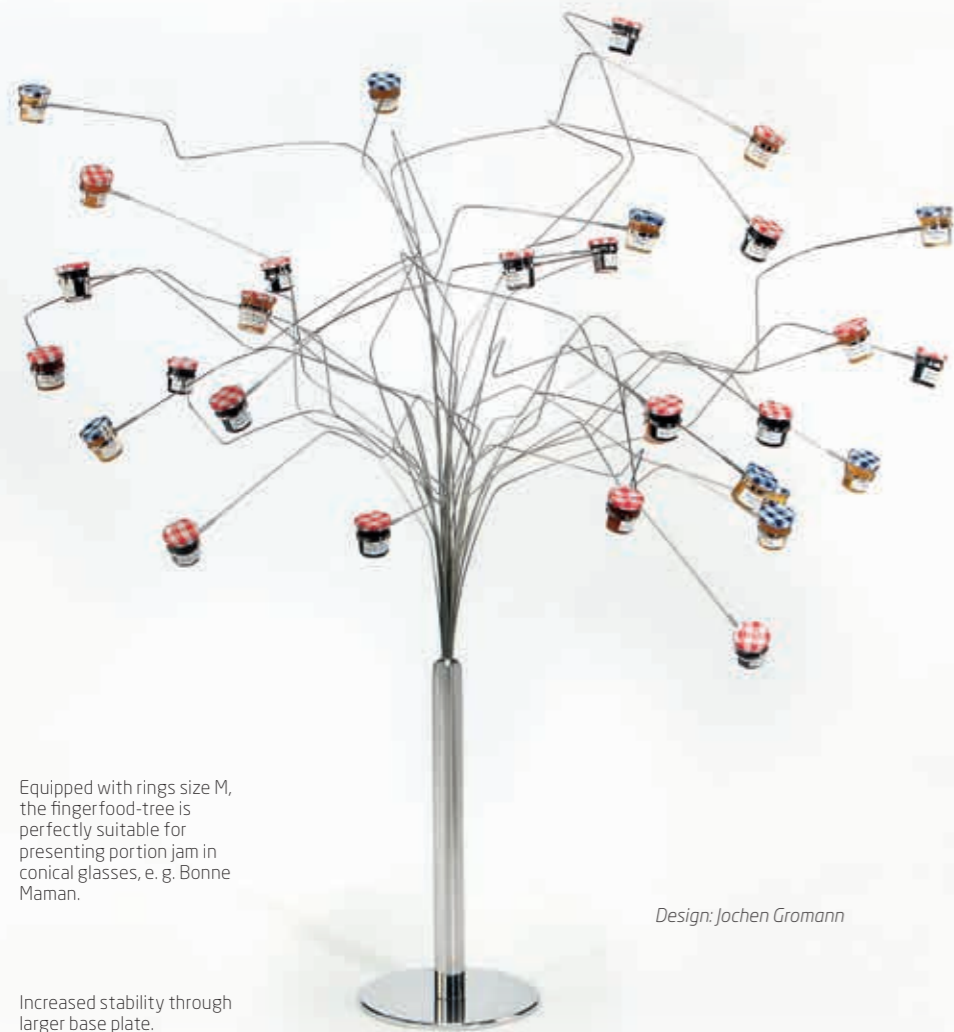

Equipped with rings size M, the fingerfood-tree is perfectly suitable for presenting portion jam in conical glasses, e.g. Bonne Maman.

Design: Jochen Gromann

Increased stability through larger base plate.

spring clip support

stainless steel 18/10, polished, to screw onto the "branches" of the fingerfood-tree item 8018.01

item	length in cm	PU
8019.01	7	10 pcs

Ring size M is suitable for portion jam in conical glasses (e.g. Bonne Maman)



ring support

stainless steel 18/10, polished, to screw onto the "branches" of the fingerfood-tree item 8018.01

item	size	Ø in cm (inside)	PU
8019.02	S	2.8	10 pcs
8019.03	M	3.8	10 pcs
8019.04	L	5.6	10 pcs



spiral support

stainless steel 18/10, polished, to screw onto the "branches" of the fingerfood-tree item 8018.01

item	Ø in cm	height in cm	PU
8019.05	4.5	4.5	10 pcs



For ring size S

glass cone

clear glass, for food display item 2194...

item	Ø / height in cm	content in l	PU
5415	3.5/8	0.03	12 pcs



For ring size L

glass miniature

borosilicate glass, transparent, handblown, double-walled, with reinforced rim

item	Ø / height in cm	content in l	PU
4901.03	6/7.5	approx. 0.08	6 pcs

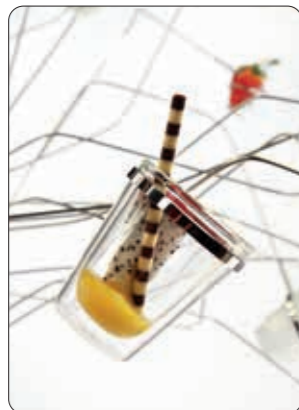

"Fingerfood-Tree"



Wildly bent tree branches, supported by a base made of polished stainless steel: The fingerfood-trees by Zieher are absolutely delightful due to their extraordinary look and variable uses achieved by the different attachments!

A number of suitable attachments and applications offer a lot of possibilities and form the basis for the chef's imagination. The fingerfood-trees are perfect for patisserie creations, savory snacks in the form of mini-wraps or skewers, fruit with chocolate icing or just for jam at breakfast buffets. Furthermore, they can be placed on both buffets and bar tables with the solid base ensuring stability.

This extraordinary way of presenting fingerfood will surprise and fascinate your guests and will definitely leave a lasting impression.

The fingerfood-trees are furnished with 30 branches, which in turn can be fitted with 5 suitable attachments (page 108). Besides a clip that holds wooden skewers and a spiral for small wraps and waffles, we offer rings in three sizes, of which the medium size is especially designed for holding small conical jam jars (e.g. Bonne Maman).

Velcro straps to fasten the branches and a stout carrier bag are available from the accessory section and allow easy transport and space-saving storage of the bent trees.



hook-and-loop strap

black, with chrome-plated clasp, for easy transport and space-saving storage of the fingerfood-tree item 8018.01

item	l x w in cm
5660	43x2.5

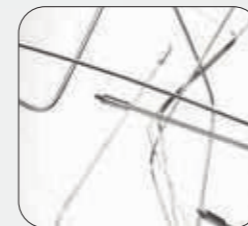

fingerfood tree

stainless steel 18/10, polished, 30 "branches" of equal length (87 cm) of stainless steel wire, with 6 feet of felt, height after bending of "branches": approx. 90 cm - 110 cm, threaded ends for attachment of several supports items 8019... (please order separately)

item	Ø in cm (foot)	height unbent in cm
8018.01	25	121



transport bag

polyester, black, with zip and 2 carrying straps, for fingerfood-tree item 8018.01

item	l x w x h in cm
8018.T	150x29x29



The "Mercato" buffet baskets made of walnut are inspired by classic market boxes, but they are superior in many respects. Finger joints in the corners for maximum stability, solid walnut in modern design as well as deliberately chosen dimensions of the heights and lateral cutouts offer numerous advantages. "Mercato" can be converted quickly and flexibly into a buffet display by the use of buffet platters. These platters (pages 50 to 57) can simply be laid on or pushed into the lateral cutouts of the baskets (max. width 21 or 34 cm). In addition to the mere presentation of fruit or baked goods, "Mercato" is also ideal for the coffee break or for placing miniatures of any kind.

The integrated rubber feet ensure safe standing and guarantee the stackability of the baskets. Bread, rolls and pastries remain crisp and fresh longer, as the slotted bottom plates allow sufficient air circulation.

The "Solid" bed tray is a nice addition to this system. Due to its integrated foldable feet, there is no need for displays for elevated positioning. For more information on the bed tray, please see page 122, for the fitting "Solid" breakfast buffet, please check pages 116 to 121.

Integrated rubber feet guarantee stackability and safe standing.



The lateral cut-outs are suitable for buffet platters with a max. width of 21 or 34 cm.



buffet display/basket "Mercato"
walnut, food-safe sealed, not dishwasher-safe, stackable, with 4 rubber feet (screwed on)

item	l x w x h in cm
4768.08	43x30x8
4768.12	43x30x12
4768.16	43x30x16

“Solid”



Please note:

The Zieher cutting boards are oiled. The use naturally wears down their surfaces. In case of smaller abrasions, rub down the surface with a thin layer of vegetable oil or special care oil for wood kitchen countertops to refresh the surface. The above mentioned items are not dishwasher-safe. Please check the enclosed leaflet for detailed instructions.



Further sizes and variations of the cloches are available on pages 114/115 and 173 to 179.



4776 + 4880.26



4776 + 4852



4778 + 4880.26



glass cloche
borosilicate glass, transparent, handblown, handmade

item	Ø in cm	height in cm
4880.26	26	approx. 41-44



glass cloche
clear glass, handblown, with round handle

item	Ø in cm	height in cm
4852	26	43



cutting board “Solid”
walnut (end grain), oiled, stackable, not dishwasher-safe, with juice rim/groove to place cloches

item	Ø in cm	height in cm
4776	29	5



stacking ring “Solid”
walnut wood, oiled, not dishwasher-safe, with stacking rim to place cloches

item	Ø in cm	height in cm
4777	29	8.5



bowl “Solid”
walnut, oiled, not dishwasher-safe, with stacking rim to place cloches

item	Ø in cm	height in cm
4778	29	8.5



buffet platter, glass
special hardened safety glass, 49 cm long, 21 cm wide, 4 mm thick, with 2 concave cutouts, rounded edges, polished rim, dishwasher-safe, rubber feet included (adhesive), underside scratch-proof

item	colour
1668.20	black
1670.20	white

“Solid”



The high-quality cutting board made of fine end grain walnut wood is much more than a shapely and elegant kitchen aid. This product only unfolds its full potential in connection with the respective stacking rings and bowls. All parts have a groove at the top, which allows quick and easy stacking of the various items, even in mixed arrangement.

The milled groove of the cutting board serves on the one hand as a juice groove, on the other hand as a receptacle for various glass cloches. Thus aromatic types of cheese can be presented. A classic cloche made of handblown glass or an extravagant organically shaped cover made of highly durable borosilicate glass protects and stages the food at the same time. The stacking ring creates different levels of presentation when used in a clustered arrangement of cutting boards and trays. Also, the capacity of the bowls can be increased so as to present, for example, long baguettes.

Accurately fitting connection plates made of hardened, white or black coloured glass, can be slid exactly into the grooves of the stacked rings and thus work as buffet platters between the columns. This creates additional space and raises the flexibility of this system at the same time. Additional sizes of these plates, made of the same type of glass (page 54/55), offer a nice supplementation and allow an optically balanced buffet presentation.

The system blends in harmoniously into the walnut wood series “Solid”. Using further sizes of the glass cloches allow impressive arrangements on the buffet. Cutting board, ring and bowl are sealed with high quality oils. Especially regarding the cutting board, this enables the simple refurbishment of the surface from traces of daily wear and tear.



4777 + 4778



4776 + 4777 + 4778



4777 + 4778



4776 + 4777 + 4778



4880.26 + 4776 + 4777 + 4778



Each cloche on this page is handblown and handcrafted. In contrast to our cloches made of borosilicate glass (page 115), these items are made of a single massive glass drop. As a result there can be air inclusions and minor streaks which cannot be avoided. Each cloche is individual, the result is a harmonic enlivenment of the buffet for an attractive price



glass cloche

clear glass, handblown, with round handle, for coaster "Solid" items 4734...

item	Ø in cm	height in cm
4850	18.5	31
4851	22.5	37
4852	26	43



glass cloche

clear glass, for pastry/cake stand items 5349...

item	Ø in cm	height in cm
5350.16	16	13
5350.23	23	16.5
5350.27	27.5	20.5



pastry/cake stand

clear glass, with foot

item	Ø in cm	Ø stand in cm	height in cm
5349.21	21	10.5	9.5
5349.28	28	13	11.5
5349.33	33.5	13	11

Cloches made of borosilicate glass are heat resistant, dishwasher-safe and very easy to handle for the guests. The main features of this material are a great resistance against heat and changes in temperature as well as a high breaking strength. Each item is manufactured by hand and therefore shaped individually.



glass cloche

borosilicate glass, transparent, handblown, handmade, for coaster "Solid" items 4734...

item	Ø in cm	height in cm
4880.18	18.5	approx. 29-32
4880.22	22.5	approx. 35-38
4880.26	26	approx. 41-44
4880.30	30	approx. 48-51

coaster/glass insert

clear glass, 4 mm thick, round, edge polished and deburred, with 4 transparent silicone feet

item	Ø in cm	for coaster "Solid" item
5244.17	16.7	4734.01
5244.21	20.7	4734.02
5244.24	24.2	4734.03
5244.28	28.2	4734.04

coaster "Solid"

walnut, food-safe sealed, not dishwasher-safe, stackable, for glass cloche items 4850, 4851, 4852 and 4880... and glass inserts items 5244...

item	Ø / height in cm	for cloches / inlays
4734.01	23/3	Ø 18.5/16.7 cm
4734.02	27/3	Ø 22.5/20.7 cm
4734.03	30.5/3	Ø 26/24.2 cm
4734.04	34.5/3	Ø 30/28.2 cm

More cloches made of glass are available on pages 173 to 179.



The cutting board is available on page 120.



The cloches "Cuspis" are available on page 176.



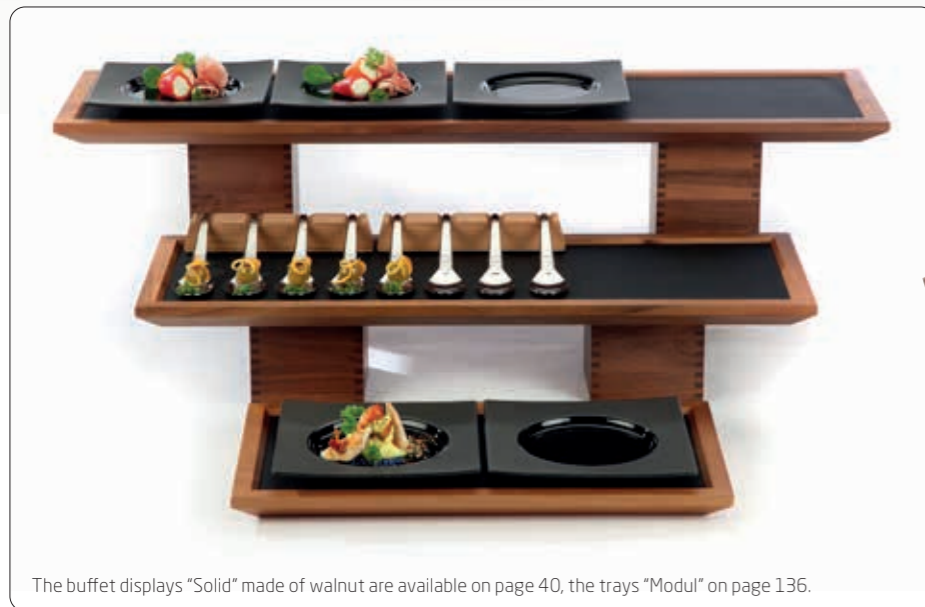

tray stand "Solid"

walnut, food-safe sealed, not dishwasher-safe, with 6 rubber feet and 16 anti-slip feet on the top side, for 2 serving trays "Solid" items 4707 and 4740

item	l x w x h in cm
4718	72.5x51x22

The buffet displays "Solid" made of walnut are available on page 40, the trays "Modul" on page 136.



tray stand "Solid"

walnut, food-safe sealed, not dishwasher-safe, removable cover strip, with 6 rubber feet and 8 anti-slip feet on the top side, 2 pieces combinable with connector piece "Solid" item 4747 (for buffet setup of two pieces item 4746 one above the other), for 1 serving tray "Solid" items 4707 or 4740

item	l x w x h in cm
4746	42x51x13.5



The cutting board and the bridge "Solid" are available on pages 120 and 121.



connector piece "Solid"

walnut, food-safe sealed, not dishwasher-safe, for buffet setup of 2 pieces of the tray stand item 4746 one above the other, with 2 boreholes for wall mounting (optional, mounting material not included)

item	l x w x h in cm
4747	46.8x12x54.5



Suitable miniatures in sizes 5 cm x 5 cm or 7 cm x 7 cm are available on pages 265 and 266.

Bread and more – attractively presented!

The presentation of bread is not only important at the table, but at the breakfast buffet, too. The variety of baked goods wants to be put in the limelight.

Oblique displays for one or two wooden trays allow for a clear arrangement of various types of bread. With the help of a connector piece, two of these tray displays (item 4746) may be stacked and used on top of each other - the ideal solution for small buffet tables. A fitting cutting board including a crumb drawer and an exchangeable grate, a cutting board made of end grain wood as well as various bridges (to be found on pages 120 and 121) complete the series and provide the healthy and diversified breakfast with a new look.

Besides the flat bread tray you can also find a deeper version of this tray, which is suited especially for the presentation of rolls, buns, biscuits and pastries. A removable grate provides air circulation, freshly baked buns remain scrumptious longer. Two kinds of divisions (for the tray) offer space for several miniatures (pages 265 and 266) and allow for a flexible use of the system. A cutlery insert for the deep tray as well as an insert for slices of toasted bread round off the range.

Solid wood from the walnut tree, which is one of the most precious and most beautiful types of wood, forms the basis for this series. Both the wood's warm brown colours in different shades and its intensive and distinctive grain make every product a unique item

Please note: Items made of walnut wood are not dishwasher-safe.



More items of the "Solid" walnut series are available on pages 234 to 245.



The miniatures made of glass and china are available on pages 265 and 266.



Glass insert
1668.03 and 1670.03
please order separately

serving tray "Solid"

walnut, flat, food-safe sealed, not dishwasher-safe, with 2 recessed grips, with 4 rubber feet

item	l x w x h in cm	l x w (inside) in cm
4707	53x37x4	50.2x34.2



tray insert "Solid"

walnut, food-safe sealed, not dishwasher-safe, divides the tray into 8 sections (length: 31.9 cm, width: 5.4 cm each), for serving trays "Solid" items 4707 and 4740 and miniatures with a max. width / Ø of 5 cm

item	l x w x h in cm
4742	50x34x2.9



tray insert "Solid"

walnut, food-safe sealed, not dishwasher-safe, divides the tray into 6 sections (length: 31.9 cm, width: 7.5 cm each), for serving trays "Solid" items 4707 and 4740 and miniatures with a max. width / Ø of 7 cm

item	l x w x h in cm
4743	50x34x2.9



glass platter

special hardened safety glass, 4 mm thick, rectangular, rounded edges, polished rim, dishwasher-safe, rubber feet included (adhesive), underside scratch-proof, for serving tray "Solid" items 4707 and 4740

item	version	l x w in cm
1668.03	black glass	50x34
1670.03	white glass	50x34



serving tray "Solid"

walnut, deep, food-safe sealed, not dishwasher-safe, 2 recessed grips, with 4 rubber feet

item	l x w x h in cm	l x w (inside) in cm
4740	53x37x10	50.2x34.2



4740 + 4745



tray insert "Solid"

walnut, food-safe sealed, not dishwasher-safe, divides the tray into 4 sections (length: 32 cm, width: 3x 13 cm and 1x 8 cm), for serving tray "Solid" item 4740

item	l x w x h in cm
4745	50x34x7



cutlery insert "Solid"

walnut, food-safe sealed, not dishwasher-safe, divides the tray into 4 sections (length: 24.9 cm, width: 11.2 cm each), for serving tray "Solid" item 4740 (for cutlery with a max. length of 24.7 cm)

item	l x w x h in cm
4744	50x27x7



grate insert "Solid"

walnut, food-safe sealed, not dishwasher-safe, with 9 rubber feet (6 mm high), for serving trays "Solid" items 4707 and 4740

item	l x w x h in cm
4741	49.8x 33.8x2



The tray stand "Solid" is available on page 276.



4707 + 4741

4707 + 4743

4707 + 4742

4707 + 1668.03
4707 + 1670.03



4740 + 4741

4740 + 4744

4740 + 4743

4740 + 1670.03



bread cutting board "Solid"

walnut, oiled, not dishwasher-safe, with 4 rubber feet, with walnut grate (39.8 cm long, 24.3 cm wide, 1.8 cm high, exchangeable) and 18/10 stainless steel drawer for crumbs (with magnetic fixing)

item	l x w x h in cm
4733	48x32.5x4.3

The changeable grate of the "Solid" cutting board has been constructed to protrude slightly from the cutting board to protect its rim



replacement grate "Solid"

walnut, oiled, for bread cutting board "Solid" item 4733

item	l x w x h in cm
4733.R	39.8x24.3x1.8



cutting board "Solid"

walnut (end grain), oiled, not dishwasher-safe, with 4 rubber feet (screwed on), in black gift box

item	l x w x h in cm
4732.PB	48x32.5x4.8



cutting board "Solid"

walnut (end grain), oiled, stackable, not dishwasher-safe, with juice rim/groove to place cloches

item	Ø in cm	height in cm
4776	29	5

Show cooking is a popular trend!

Whether using it for catering, at events or at the hotel's own buffet, the solid wood cutting boards by Zieher are pleasing eyecatchers and offer high functionality. The matching bridges can be equipped with bowls, putting everything tidily within reach for the work behind the buffet.

The dimensions of both cutting boards and bridges have been chosen in such a way, that exactly two boards and two bridges would fit into a regular transportation box. This is extremely useful when it comes to storing the items for their daily use and transportation for catering purposes.

"Solid" is entirely made of walnut, probably one of the most beautiful and most stylish woods.

More items from this series can be found on pages 234 to 245.



Please note:



The Zieher cutting boards are oiled. The use naturally wears down their surfaces. In case of smaller abrasions, rub down the surface with a thin layer of vegetable oil or special care oil for wooden kitchen countertops to refresh the surface. The removable grate for the bread cutting board (item 4733) can be ordered separately as a spare part (item 4733.R). The above mentioned items are not dishwasher-safe. Please check the enclosed leaflet for detailed care instructions.

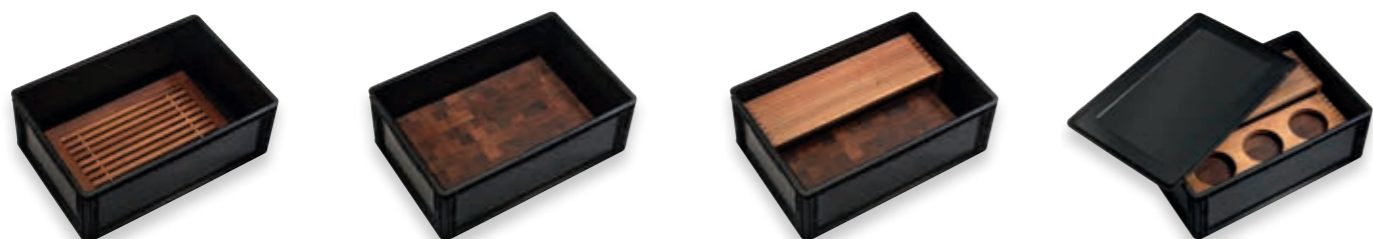

Stackable in all usual transport boxes with a size of 60 cm x 40 cm (e. g. meat box, height approx. 20 cm)



bridge "Solid"

walnut, food-safe sealed, not dishwasher-safe, with 4 rubber feet

item	l x w x h in cm
4730	54x17x16



bridge "Solid"

walnut, food-safe sealed, not dishwasher-safe, with 3 tapered holes (Ø 12 cm top side/11 cm underside), with 4 rubber feet, for bowls with max. Ø 15 cm

item	l x w x h in cm
4731	54x17x12



bowl "Shine"

stainless steel 18/10, outside polished, double-walled, round/oblique, Ø 15.7 cm, 6.7 / 8.8 cm high, 0.5 l content, for bridge "Solid" item 4731

item	colour inside
2260.16	satined (dishwasher-safe)
2261.16	ivory (not dishwasher-safe)
2262.16	taupe (not dishwasher-safe)



bowl "Catering de Luxe"

china, white, for bridge "Solid" item 4731

item	Ø / height in cm	content in l	PU
4281	14/7.5	0.35	6 pcs



"Solid"



bed tray "Solid"

walnut, food-safe sealed, not dishwasher-safe, stackable, with feet, 2 handles, recessed on one side of the rim

item	l x w x h in cm (closed)	l x w x h in cm (set up)
4773	60x40x6.5	74x40x31



The rubber feet are set back from the rim to enable the transport in a tray trolley in 1/1 EN-format (60 cm x 40 cm).

The room service tray as well as the bed tray with feet stand out due to the precious walnut wood, which is incorporated into these products with high-quality craftsmanship. The recessed longside enables comfortable dining directly off the tray. The retractable feet of the bed tray have been constructed in a very stable way and are securely kept in position by integrated magnets when folded in. The tray also cuts a good figure on the buffet. The positioning feet make it possible to dispense with the use of displays for heightened placing. A speedy setup and flexible handling facilitate daily operations.



The tray stand for the roomservice tray item 4735 is available on page 276.



The serving tray and suitable glass inserts are available on page 280, more "Solid" items on pages 234 to 245.



room service tray "Solid"

walnut, food-safe sealed, not dishwasher-safe, stackable, recessed on one side of the rim, with 2 handles, with 4 rubber feet, suitable for tray stand "Solid" item 4748

item	l x w x h in cm
4735	60x40x5.4



serving tray "Solid"

walnut, food-safe sealed, not dishwasher-safe, with 4 rubber feet

item	l x w x h in cm	l x w in cm (inside)
4713	34x34x3	32x32



serving tray "Solid"

walnut, food-safe sealed, not dishwasher-safe, stackable, 2 compartments: 30 cm x 30 cm and 30 cm x 8 cm (for cutlery or china/glass bowls), with 4 rubber feet

item	l x w x h in cm
4769	41.7x32.5x6.7

All information about the serving tray "Solid" item 4769 is available on page 280.

"Solid"



serving tray "Solid"

walnut, oiled, not dishwasher-safe, with changeable insert made of black coloured ceramic

item	l x w in cm
4780.46	46.5x23
4780.67	67.5x33



insert/platter

coloured ceramic, 6 mm thick, black, dishwasher-safe

item	l x w in cm
4780.46S	39x19.5
4780.67S	59x29



The cutting boards are pluggable and can be connected with each other.



cutting/snack board "Connect!"

walnut, oiled, not dishwasher-safe, pluggable, with handle, with 4 rubber feet

item	l x w x h in cm	length incl. handle
4775.44PB	40x16x2.3	44.5



cutting/snack board "Connect!"

walnut, oiled, not dishwasher-safe, pluggable, with handle, with 4 rubber feet

item	l x w x h in cm	length incl. handle
4774.31PB		31

Please note:



Please note the care instructions: not dishwasher-safe, do not immerse in water!



All information about the trays and suitable inserts are available on page 234.

"Connect!"



Serving platters made of walnut!

Sublime in their appearance, unadorned in design, practical by compact formats and highly functional in combination - the solid wood boards of the series "Connect!" convince as a snack board, serving and cutting board or as a presentation platter, created by the combination of several elements. "Connect!" is an extremely versatile tool for everyday use. All information about "Connect!" are available on page 235.

"Solid"



card holder

walnut, varnished, slot 2 mm wide

item	l x w x h in cm	PU
4726	8x3x3	4 pcs



bowl "Solid"

walnut, oblique, food-safe sealed, not dishwasher-safe

item	Ø in cm	height in cm
4761	14	9



bread basket "Solid"

walnut, food-safe sealed, not dishwasher-safe, boat-shaped

item	l x w x h in cm
4770.24	24.5x12x5

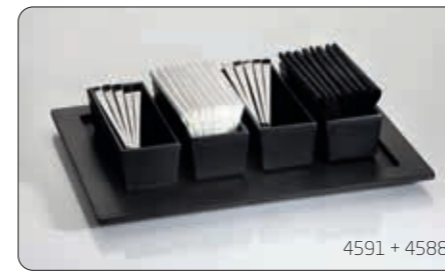

4591 + 4588



cutlery/napkin box

melamine, black, surface matt, food-safe, dishwasher-safe, with 4 rubber feet, not suitable for microwave and combi steam oven, for cocktail napkins folded to 1/8

item	l x w x h in cm	content in l	PU
4591	16x6x4.5	0.26	2 pcs



4594 + 4589



The melamine tray item 4589 in 1/1 GN format is available on page 131.

Grooves to let the water from the dishwasher run off



cutlery box

melamine, black, surface matt, food-safe, dishwasher-safe, not suitable for microwave and combi steam oven, for cutlery with a length of up to 23.5 cm

item	l x w x h in cm	content in l	PU
4594	26.5x16.2x7.2	2.25	4 pcs



cutlery box "Solid"

walnut, food-safe sealed, not dishwasher-safe, with acrylic glass lid, with 4 rubber feet, for cutlery with a length of up to 24.3 cm

item	l x w x h in cm
4720	26.5x16.2x8

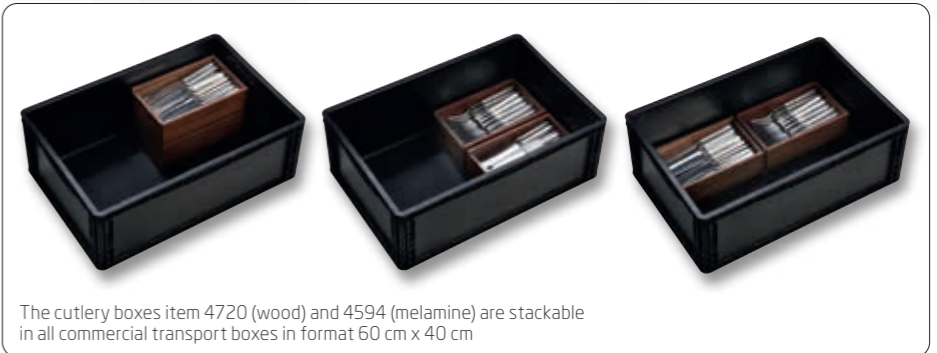

The cutlery boxes item 4720 (wood) and 4594 (melamine) are stackable in all commercial transport boxes in format 60 cm x 40 cm



The platter made of dark grey glass is available on page 168.



cutlery/napkin box "Solid"

walnut, food-safe sealed, not dishwasher-safe, with rubber feet in the lid (soft closure, can be opened to an angle of 90° only) and at the bottom, with black felt insert, stainless steel platter with space for an engraving (price and quantity upon request), height with open lid: 15.5 cm

item	l x w x h in cm	size inside in cm
4766	28.8x11.8x6	26x8.7



buffet display "Solid"

walnut, food-safe sealed, not dishwasher-safe, bottom side open, can be used as a stand or as a container

item	l x w x h in cm	PU
4767.12	12x12x12	2 pcs
4767.24	12x12x24	2 pcs



"Podia"



Hotel cosmetics: PAM Berlin Slipper & Hotel Supplies
www.pam-berlin.de

The buffet bridges and trays of the "Podia" series offer several advantages!

They are light but robust, flexibly usable and can be stored in a space-saving way. With its use as a display on the buffet, during coffee break or as a platter for fruit or little somethings in the hotel room - "Podia" offers multiple possibilities for use and flexible handling!

The tray in 1/2 GN format is especially suitable for different miniatures made of porcelain and glass. Slide-proof silicone coasters in different styles (page 214) guarantee a good grip during service.

All parts of this series consist of form-glued authentic wood veneer. The bridges are available in two types of wood. The light version harmonises very well with mundane but also with rustic-style furnishing, the version with the black-brown stripes appears exotic and modern.

Please note: 
Not dishwasher-safe!
Do not immerse in water!



1/2 GN tray "Podia"
genuine wood veneer, dark (black-brown striped), not dishwasher-safe

item	l x w in cm	GN	PU
8732.03	32.5 x 26.5	1/2	6 pcs



buffet bridge "Podia", triple pack
genuine wood veneer, not dishwasher-safe, set consists of size S (30x20x6cm), size M (36x20x9cm) and size L (42.5x20x12cm)

item	version	PU
8730	dark colouring (black-brown striped)	1 set



buffet bridge "Podia", triple pack
genuine wood veneer, not dishwasher-safe, set consists of size S (30x20x6cm), size M (36x20x9cm) and size L (42.5x20x12cm)

item	version	PU
8731	light colouring (similar to oak)	1 set



Catering

More products from the room service/hotel room field are available as of page 275.



Available in different colours from 350 sets (box + lid) upon request!

The lid of the Zieher Bento Box is also suitable as shapely tray. The champagne flute "Vaganza" is available on page 202.



insert/box

melamine, black, surface matt, stackable, food-safe, dishwasher-safe, not suitable for microwave and combi steam oven, up to 4 pieces fit into item 4578

item	l x w x h in cm	PU
4580	29.5x9x3.3	3 pcs



lid/tray

melamine, black, surface matt, stackable, food-safe, dishwasher-safe, not suitable for microwave and combi steam oven, with ventilation slots, suitable for item 4578, also usable as a tray

item	l x w x h in cm
4579	39.5x31.5x4

"Bento Box" - flexible mobility

Serving guests at the pool, beach or on the terrace is often associated with longer walking distances for service staff. The "Bento Box" from Zieher has been designed especially for these requirements - all components are stackable. This way, they guarantee a space-saving storage and a comfortable, non-slip transport, even with several dishes at the same time.

Matt black melamine, modern design and subtle contrasts created by different surface structures, form the perfect setting for individual creations and popular classics such as burgers, club sandwiches or salads.

The box is divided into a main compartment for plates up to a diameter of 28 cm and a narrow side compartment for cutlery and napkin or miniatures made of glass and porcelain.

Optionally available inserts in the same design create additional space for side dishes, sauces or dips, when placed above the cutlery compartment. Up to four of these boxes can be placed in a bento box if required, and, with a correspondingly flat content of the main compartment, create a second level for even more flexibility.

The versatility of the individual components also becomes evident in the cover, which has decorative ventilation slots to dissipate steam generated by hot food. This lid can also be used as a tray, whose less finely textured inside has an anti-slip effect.

Box, insert box and lid are sold separately and can be combined as desired. This allows the restaurateur the adaption to his individual needs and helps to optimise additional purchases.



Bento Box

melamine, black, surface matt, stackable, food-safe, dishwasher-safe, not suitable for microwave and combi steam oven, partition for cutlery/napkin/inserts (28 cm x 7.5 cm) or for platters (28 cm x 28 cm)

item	l x w x h in cm
4578	39x30.5x8.5



Suitable inserts made of glass and china (7 cm x 7 cm) are available on page 266.





Please note:



Items made of melamine are not to be used for cooking in microwave and combi steam oven!

- Dishwasher-safe
- Food-safe
- Odourless
- Easy-care
- Modern design with matt-black surface

Real added value is provided by different boxes made from the same material. They are available as an insert for the bento box (page 129) and as a cutlery box in two sizes. In addition, three smaller variants have been developed, paying particular attention to the greatest possible compatibility with the trays. The boxes can be arranged in a variety of combinations on all melamine trays and thus offer enormous potential for a use at the Flying Buffet, in catering, at the bar or at the breakfast buffet. A selection of suitable combinations is available on the following pages.

The sturdy containers can also be used as plain elevations for platters and trays. Without additional efforts in procuring material, it is possible to arrange varied buffet presentations quickly and easily. Additionally available are different versions with three round or oval cavities. A big selection of suitable inserts made of glass or porcelain is available on page 268 and 269.

bowl/box

melamine, black, surface matt, food-safe, dishwasher-safe, not suitable for microwave and combi steam oven

item	l x w x h in cm	content in l	PU
4598.09	9x6.3x4.5	0.25	6 pcs
4598.13	12.8x9x4.5	0.35	4 pcs

bowl/box

melamine, black, surface matt, food-safe, dishwasher-safe, not suitable for microwave and combi steam oven, up to 4 pieces fit into item 4578

item	l x w x h in cm	content in l	PU
4599.13	12.8x12.8x4.5	0.51	4 pcs

insert/box

melamine, black, surface matt, stackable, food-safe, dishwasher-safe, not suitable for microwave and combi steam oven, up to 4 pieces fit into item 4578

item	l x w x h in cm	content in l	PU
4580	29.5x9x3.3	0.55	3 pcs

cutlery/napkin box

melamine, black, surface matt, food-safe, dishwasher-safe, with 4 rubber feet, not suitable for microwave and combi steam oven, for cocktail napkins folded to 1/8

item	l x w x h in cm	content in l	PU
4591	16x6x4.5	0.26	2 pcs

cutlery box

melamine, black, surface matt, food-safe, dishwasher-safe, not suitable for microwave and combi steam oven, for cutlery with a length of up to 23.5 cm

item	l x w x h in cm	content in l	PU
4594	26.5x16.2x7.2	2.25	4 pcs



The spoon rest made of melamine is available on page 134, suitable spoons and skewers on pages 140 and 141.



The "Modul" trays made of walnut are available on page 136, suitable inserts made of glass and china on pages 140 to 142.



base tray "Modul"

melamine, black, surface matt, food-safe, dishwasher-safe, not suitable for microwave and combi steam oven

item	l x w x h in cm	PU
4581	53x28x1.8	2 pcs
4582	72.5x28x1.8	2 pcs
4583	95.5x28x1.8	2 pcs



GN tray

melamine, black, surface matt, food-safe, dishwasher-safe, not suitable for microwave and combi steam oven

item	l x w x h in cm	GN	PU
4587	32.5x17.6x1.8	1/3	2 pcs
4588	32.5x26.5x1.8	1/2	2 pcs
4589	53x32.5x1.8	1/1	2 pcs

tray

melamine, black, surface matt, food-safe, dishwasher-safe, not suitable for microwave and combi steam oven

item	l x w x h in cm	PU
4586	25.2x13.2x1.8	2 pcs

Robust and elegant - melamine!

The advantages of melamine, such as dishwasher-resistance and food-safety, are particularly evident in daily catering use.

The matt black surface of the Zieher melamine articles generates a superb contrast to glass and porcelain and impresses by its pleasant haptics.

Modern design and the simple language of form of the trays, which are available in common GN formats, make up a pleasant addition to the articles of the "Modul" series (page 140/141). The bridges and spoon rests (page 138) can be used on all trays, non-skid rubber feet on the bottom side facilitate the service enormously.





4594 + 4589



4588 + 4598.13 + 4599.13



4589 + 4594



4589 + 4598.13 + 4599.13



4588 + 4598.13



4589 + 4598.13 + 4599.13



4588 + 4591



4589 + 4598.13



4588 + 4598.09

Please note:
Items made of melamine are not to be used for cooking in microwave and combi steam oven!



4591 + 4588



4587 + 4599.13



4587 + 4598.13



4586 + 4591



4586 + 4598.09



4587 + 4598.09

The boxes can be arranged in a variety of combinations on all melamine trays and thus offer enormous potential for a use at the Flying Buffet, in catering, at the bar or at the breakfast buffet.

A small range of possible combinations is shown here, all melamine trays and inserts shown on this double-page are available on page 130 and 131.



4583 + 4598.09 + 4598.13



4583 + 4598.09 + 4598.13



4582 + 4598.13



4582 + 4598.09 + 4598.13



4582 + 4598.09 + 4598.13



Individualisation as of 300 pieces upon request.



4581 + 4598.13



4581 + 4598.09 + 4598.13



Inserts made of glass and china, suitable for item 4590 are available on page 269.



4593 + 4081.12



4593 + 5444



The party spoon item 1938... is available on page 140.

glass bowl

clear glass, oval

item	l x w x h in cm	content in l	PU
5444	12.5x7x4	0.08	6 pcs



bowl

china, white, oval

item	l x w x h in cm	content in l	PU
4081.12	12.5x7x4	0.1	12 pcs



2/8 GN tray

melamine, black, surface matt, food-safe, dishwasher-safe, not suitable for microwave and combi steam oven, with 3 oval sockets (diagonal), for small bowls items 4081.12 (china) and 5444 (glass)

item	l x w x h in cm	PU
4593	32.5x13.2x1.8	2 pcs



2/8 GN tray

melamine, black, surface matt, food-safe, dishwasher-safe, not suitable for microwave and combi steam oven, with 3 round sockets (Ø 5.5 cm / 8.2 cm)

item	l x w x h in cm	PU
4590	32.5x13.2x1.8	2 pcs



The trays of the “Modul” Series and suitable inserts made of glass and china are available on pages 138 to 141.



bridge “Modul”

melamine, black, surface matt, food-safe, dishwasher-safe, not suitable for microwave and combi steam oven, 5 graded sockets (Ø top 5 cm, Ø bottom 2.5 cm), for several glass items (5257, 5405,...), with 4 rubber feet (black)

item	l x w x h in cm	PU
4584	41.5x7.7x6	2 pcs



spoon rest “Modul”

melamine, black, surface matt, food-safe, dishwasher-safe, not suitable for microwave and combi steam oven, with 4 rubber feet (black)

item	l x w x h in cm	PU
4585	20x5x4	2 pcs



serving tray “Solid”

walnut, food-safe sealed, not dishwasher-safe, stackable, 2 compartments: 30 cm x 30 cm and 30 cm x 8 cm (for cutlery or china/glass bowls), with 4 rubber feet

item	l x w x h in cm
4769	41.7x32.5x6.7



cutlery box “Solid”

walnut, food-safe sealed, not dishwasher-safe, with acrylic glass lid, with 4 rubber feet, for cutlery with a length of up to 24.3 cm

item	l x w x h in cm
4720	26.5x16.2x8



The cutlery/napkin box for the table is available on page 241



Further trays made of walnut are available on pages 110 to 123.

All information about the serving tray “Solid” are available on page 280.



The cutlery boxes item 4720 (wood) and 4594 (melamine) are stackable in all commercial transport boxes in format 60 cm x 40 cm



Solid wood from the walnut tree, which is one of the most precious and most beautiful types of wood, forms the basis for this series. Both the wood’s warm brown colours in different shades and its intensive and distinctive grain make every product a unique item. The high-quality workmanship in combination with the food-safe sealing guarantees long durability, even in everyday use.



The party spoon items 1938... are available on page 140.



base tray “Modul”

walnut, food-safe sealed, not dishwasher-safe, stackable

item	l x w x h in cm
4721	47.5x25.5x3.1
4722	70x25.5x3.1
4723	92.5x25.5x3.1



The finger-groove on the bottom side of the tray guarantees safe and simple handling.



bridge “Modul”

walnut, food-safe sealed, not dishwasher-safe, with 5 graded sockets (Ø top 5 cm, Ø bottom 2.5 cm), with 4 rubber feet

item	l x w x h in cm
4724	42.5x9x6.5



spoon rest “Modul”

walnut, food-safe sealed, not dishwasher-safe, with 4 rubber feet

item	l x w x h in cm
4725	21x3.2x3.8



buffet display “Solid”

walnut, food-safe sealed, not dishwasher-safe, bottom side open, can be used as a stand or as a container

item	l x w x h in cm	PU
4767.12	12x12x12	2 pcs
4767.24	12x12x24	2 pcs

Please note:



Items made of walnut wood are not dishwasher-safe, do not immerse in water!

Suitable inserts for the bridge “Modul” are available on page 142.

“Modul” is a flexible product ready for “Flying Buffet” service - and therefore ideally suited for use in the catering area. The slim, oblong format of the base tray, which is available in three sizes, renders the often cumbersome service at crowded standing receptions barrier-free and uncomplicated. The trays can be variably fitted with glass or porcelain parts, a bridge for glasses or a spoon bench for 4 spoons. When using two spoon benches, 4 long skewers can be placed safely on top.

Every single piece has been specially developed for this catering system. Trays, bridge and spoon rest are available in 2 variations: The series “Modul” is manufactured from solid walnut wood and from melamine in a modern matt-black design (pages 130 131, 138 and 139). Suitable miniatures made of china and glass (pages 140 to 142) can be fitted to all trays! Shapely anti-slip mats made of silicone (page 143) facilitate catering to a great extent.



The buffet stands “Antique” are available on page 46. More items made of walnut are available on pages 110 to 125 and 234 to 245.

"Modul" – melamine

The advantages of melamine are manifold. It is dishwasher-safe and food-safe, which becomes evident in daily catering use! The smallest tray is 53 cm long and is therefore partially compatible with existing GN-systems. All trays are stackable.

Besides the merely technical properties, the flat black trays differ from the variant made of walnut by their modest design and modern appearance.

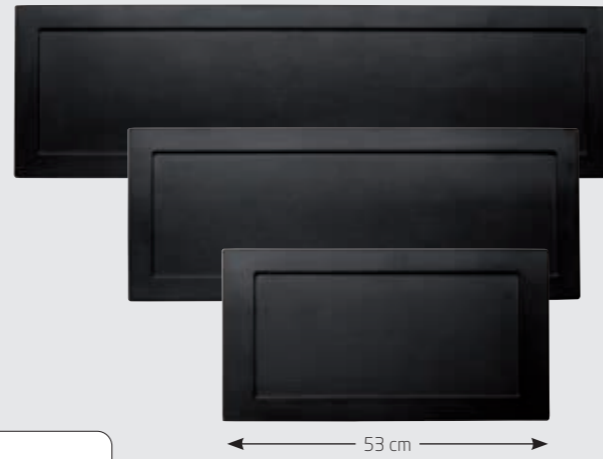

base tray "Modul"

melamine, black, surface matt, food-safe, dishwasher-safe, not suitable for microwave and combi steam oven

item	l x w x h in cm	PU
4581	53x28x1.8	2 pcs
4582	72.5x28x1.8	2 pcs
4583	95.5x28x1.8	2 pcs



The grooves at the bottom side of the tray let water from the dishwasher run off.



bridge "Modul"

melamine, black, surface matt, food-safe, dishwasher-safe, not suitable for microwave and combi steam oven, 5 graded sockets (Ø top 5 cm, Ø bottom 2.5 cm), for several glass items (5257, 5405,...), with 4 rubber feet (black)

item	l x w x h in cm	PU
4584	41.5x7.7x6	2 pcs



spoon rest "Modul"

melamine, black, surface matt, food-safe, dishwasher-safe, not suitable for microwave and combi steam oven, with 4 rubber feet (black)

item	l x w x h in cm	PU
4585	20x5x4	2 pcs

More trays made of melamine in GN-dimensions are available on page 131, the cutlery/napkin box on page 130.



The plate "Modul" item 4383 is available on page 141.



The skewers 1939.02 are available on page 141.



The party spoons items 1938... are available on page 140.



Suitable inserts for the bridge are available on page 142.

"Modul" – melamine

- Modern design with matt-black surface
- Dishwasher-safe
- Food-safe
- Odourless
- Easy-care



The buffet stands "Lightning Buffet" are available on page 48.



walnut with anti-slip mat (page 143)



bowl "Modul"

china, white, square, deep, for base trays "Modul" made of walnut and melamine

item	l x w in cm	content in l	PU
4381	11x11	0,07	12 pcs



plate "Modul"

china, white, square, flat, item 4385.22 fits base trays "Modul" made of walnut and melamine

item	l x w in cm	PU
4385.22	22x22	6 pcs
4385.27	27x27	4 pcs

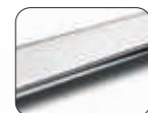

party spoon

stainless steel 18/10, 4.3 mm thick, heavy quality, 21 cm long

item	version
1938	polished
1938.01	hammered



"Modul" - variations



plate "Modul"

china, white, rectangular, flat, for base trays "Modul" made of walnut and melamine

item	l x w in cm	PU
4383	22x11	12 pcs



amuse gueule/tapas spoon

china, white

item	l x w x h in cm	PU
4260.01	13x4x3	12 pcs



spoon rest "Modul"

melamine, black, surface matt, food-safe, dishwasher-safe, not suitable for microwave and combi steam oven, with 4 rubber feet (black)

item	l x w x h in cm	PU
4585	20x5x4	2 pcs



skewer

stainless steel 18/10, polished, 24 cm long

item	version	PU
1939.01	Moon	12 pcs
1939.02	Flame	12 pcs



cutlery/napkin box

melamine, black, surface matt, food-safe, dishwasher-safe, with 4 rubber feet, not suitable for microwave and combi steam oven, for cocktail napkins folded to 1/8

item	l x w x h in cm	content in l	PU
4591	16x6x4.5	0,26	2 pcs



melamine



melamine with anti-slip mat (page 143)





The "Modul" base trays made of walnut and melamine combine well with Zieher items from the same series and beyond. Here are some suggestions:



small bowl
china, white, square

item	l x w x h in cm	content in l	PU
3853	7x7x2	0.05	12 pcs



small bowl
china, square, 4.9 cm long, 4.9 cm wide, 4.5 cm high, 0.05 l content

item	version	PU
3845	china	4 pcs
5254	clear glass	4 pcs



glass miniature
clear glass, for bridges "Modul" items 4584 and 4724

item	Ø / height in cm	content in l	PU
5405	5/8.6	0.1	6 pcs



glass miniature
clear glass, for bridges "Modul" items 4584 and 4724

item	Ø / height in cm	content in l	PU
5257	7/10	0.08	12 pcs



glass miniature
clear glass, wavy rim, base: 0.07 l content, top part: 0.04 l content, for bridge "Modul" items 4584 and 4724

item	version	Ø / height in cm	PU
5423.01	base	6.5/5.5	12 pcs
5423.02	top	6.3/4.5	12 pcs



glass bowl
borosilicate glass, flat

item	Ø / height in cm	content in l	PU
4910	10.5/2.5	0.18	12 pcs



test tube
borosilicate glass (temperature change resistant), with flanged rim and round bottom, for holder for test tube item 4680.S and cork item 1501

item	Ø / height in cm	content in l	PU
4032.G	2/15	0.04	24 pcs

cork
for test tube item 4032.G

item	Ø in cm	length in cm	PU
1501	2/1.7	2.6	24 pcs



holder for test tubes
silicone, Ø 4.6 cm, 2.7 cm high, with grooves on the inside for easy insertion of glass tubes, for test tube item 4032.G

item	colour	PU
4680.S	black	6 pcs



Non-slip covers in matt black: Classy look - great benefit!

The matt black look and velvety texture of these mats create an interesting contrast when used in connection with the trays made of walnut. In combination with the "Modul" melamine trays they become almost invisible.

The mats made of food-safe silicone are extremely skid-proof and facilitate the serving considerably. No clattering, no shifting of porcelain bothers guests and staff!

To clean the mats, please use a moist cloth with some detergent and wipe off with a cloth and clear water.



Non-slip coasters for single miniatures are available on page 214.



The mats are made to match the size of the walnut trays Art.-Nr. 4721, 4722 and 4723. With a sharp cutter knife, they can be adapted to the size of the melamine trays Art.-Nr. 4581, 4582 and 4583. We recommend to use a cutting mat as well as a metal ruler.

non-slip mat
silicone, black, food-safe, temperature resistant (-40 °C - +230 °C), for walnut trays "Modul" items 4721, 4722 and 4723, can be cut to fit melamine trays "Modul" items 4581, 4582 and 4583

item	l x w in cm	PU
4660.01	42.6x20.6	6 pcs
4660.02	65.1x20.6	6 pcs
4660.03	87.6x20.6	6 pcs



VENTA by Büchin Design has developed an elegant buffet furniture programme for the high demands of the hotel industry and for exclusive events. It is equipped with a number of technical features to keep food hot or cold.

The tables are equipped with castors and can therefore be used very flexible in different rooms. They can be stored under each other or dismantled and stored in trolleys in just a few simple steps.

Zieher and VENTA cooperate in the area of buffet presentation. The Zieher table-top buffet elements harmonize excellently with the modular buffet system "STAGE" of the VENTA brand.



MODULAR BUFFET SYSTEM

- Adjustable heights
- Movable castors
- Nesting storage
- Trolley Transport System



total buffet length: 536 cm



all tables in a row / adjusted at the same height

The modular buffet table system STAGE can be assembled and disassembled in just a few easy steps, without the need for any tools.



All four tables fit in one trolley. The individual parts are safely stored, each part has its own place.



All details of VENTA system you will find at: www.ventadesign.com



Making precious materials more precious – whether it is ...



"platin"



"gold"



"bronze"

... glass or china: nearly everything is possible!

Large-scale coatings on glass and china in precious colours enrich every dining table and create luxurious accents!

In order to achieve this decorative style, available in gold, platinum and bronze, the precious metals are burnt onto the varnish at more than 880 °C and as a result, the coating is dishwasher-safe. Cloches made of glass can now be used for serving warm dishes as well and condensing water remains invisible to a great part.

By using resistant precious alloys, we obtain a connection to the varnish, which is strong enough for the products to become dishwasher-safe. Test series by the "Institut für Werkstoffe Heraeus Precious Metals GmbH & Co. KG" have proven the dishwasher resistance of the décor. Partially, the possibilities of coating are dependent on the form of the product. Requests are being tested in each case according to their feasibility.

The bronze colour is a special case since it presents itself in numerous interesting shades of colour. Depending on the shape of the product, especially when looking at immersions, the colours can vary from gold-bronze shades to blue-violet ones, which blend into each other and create unique effects. Specific patterns/orders are usually executed quickly. Please do not hesitate to send us your special request



Satin-coated logos applied before the refinement still remain visible.

colour gradient "bronze"



All information of refining stainless steel are available on page 301.

Please note:



Products are dishwasher-resistant. Please take note of the instructions given by dishwasher producers and detergents to avoid damage.

Since the coatings are made of precious metals, the use in microwaves is not recommended under any circumstances

"Cuspis"



The large cloche "Cuspis" and the suitable plateau plate are available on page 152.



Borosilicate glass in its most beautiful shape!

The primary design element of the series "Cuspis" is a glass ball studded with fine spikes. The cloches with a fitting porcelain plateau plate/mini bowl are available in three sizes and the inspiration for their shaping was derived from the nut of the oak tree.

The star-shaped handle is located at the top of the cloches and allows for an uncomplicated handling of these classy covers. The unglazed outside of the porcelain bowls is reminiscent of acorn caps. The bowls can be used on both sides. When used as a plateau plate, the dishes move closer to the guest, while the filigree glass cloche protects the presented delicacies and puts them in the limelight at the same time. Used as a bowl, it offers space for gravies, sauces and more.

glass cloche "Cuspis"
borosilicate glass, transparent, handblown, star-shaped ball handle

item	for plate/bowl	Ø in cm	height in cm
4940.08	4389.09	8.5	12.5
4940.10	4389.11	10.5	14.5



plateau plate/small bowl "Cuspis"
china, white, inside and useable area (plateau Ø approx. 6 cm/8 cm) glazed, outside biscuit, also useable as a bowl

item	Ø in cm	height in cm	content in l
4389.09	9	3	0.1
4389.11	11.5	3.5	0.18

Design: Michael Schwarz Müller

Miniatures



The mini bowl "Splash" is available on page 69.



chopsticks
borosilicate glass, satined, handmade, please note the safety instructions on each pack (not suitable for children)

item	length in cm	PU
4885	21.5	1 set (2 parts)



chopstick/knife rest "Flex"
borosilicate glass, transparent, handmade

item	l x w in cm	height in cm	PU
4886	8x2.3	approx. 2.3	2 pcs



dip bowl/miniature "Flex"
borosilicate glass, transparent, handmade, with recess

item	l x w in cm	height in cm	PU
4889.16	16x7	approx. 2.8	4 pcs



platter/miniature "Flex"
borosilicate glass, transparent, handmade, wavy

item	l x w in cm	height in cm	PU
4888.16	16x8	approx. 2	4 pcs
4888.22	22x11	approx. 2.5	4 pcs



"Flex" - Perfectly designed and beautiful!

Tubes made of borosilicate glass – shaped into unique pieces by way of heat exposure. These perfectly designed elements of the "Flex" series can only be manufactured in such a sophisticated quality by extremely precise control of timing at exact temperatures.

Elegant presentation plates for amuse-bouches, fingerfood and other artfully arranged delights of upscale cuisine originate from this complex procedure. The "Flex" series is also suitable for intermediate courses or smaller desserts as well as presentations of bread and oil or dips.

The artfully curved inside of the tubes offers creative space for cutlery or napkins, decorative herbs, edible blossoms and more!

A rest for knives or chopsticks in the same language of design blends harmonically into this series. Chopsticks made of borosilicate glass are the perfect completion for this line. The satined surface of the sticks provides for pleasant haptics and creates an appealing contrast to the clear glass of the rest.



Design: Michael Schwarzmüller
Idea and concept: Zieher

No sliding, no clattering – with non-slip pads by Zieher!



The china series "DressCoat" is available on pages 156 and 157

The coasters made of food safe silicone are shapely accessories with a highly practical benefit. Clattering and wildly sliding miniatures on plates and trays are a thing of the past.

The skid-proof discs with their delicately structured, matt surface facilitate the service's work and ensure undisturbed enjoyment for the guest.

The coasters are available in two colours; the white ones can be integrated discreetly, whereas the black ones can be used deliberately as contrasting, decorative elements



coaster

silicone, Ø 5 cm, 3 mm thick, temperature resistant (-40 °C to +230 °C), food-safe, with rim on one side, for anti-slip placement of miniatures

item	colour	PU
4661.05S	black	24 pcs
4661.05W	white	24 pcs



ring "SelectionA."

silicone, Ø 8.3 cm, for the anti-slip placement of small glass bowl item 4930 and 5478

item	colour	PU
4681.S	black	6 pcs



4930 + 4681.S

These spherical bowls made of borosilicate glass accentuate in particular artfully presented dishes by their minimalistic and elegant design. The flattened bottom of the bowls ensures a safe and even stand. Optionally available silicone rings for the small version guarantee skid-resistance and also allow a positioning at an angle. All bowls are made of borosilicate glass, whose strength, temperature resistance, high transparency as well as absence of bubbles guarantee a high quality product experience.



The baskets of the "Reef" series are available on page 219.



small glass bowl

borosilicate glass, handblown, round

item	Ø / height in cm	content in l	PU
4930	7/5	approx. 0.14	24 pcs



NEW

wine glass lid "Tesoro"

borosilicate glass, transparent, handblown

item	Ø in cm	height in cm	PU
5478	9	2.3	2 pcs.
5478-06	9	2.3	6 pcs.



All information about the wine glass lid "Tesoro" are available on page 188 and 189.

Double-walled thermo glasses



Handblown, double-walled glasses made of borosilicate glass combine spectacular optics and extraordinary technical features. The vacuum between the two glasses prevents the formation of condensate on the outside of the glass when the ambient temperature is warm and the drinks are cold. The isolation effect keeps cold and warm liquids cold or warm for a longer time. Borosilicate glass by Zieher stands out due to its hardness and high temperature resistance.

glass bowl

borosilicate glass, transparent, handblown, double-walled

item	Ø / height in cm	content in l	PU
4956.01	9/4	approx. 0.07	6 pcs
4956.02	11/5.5	approx. 0.15	6 pcs
4956.03	13/6.5	approx. 0.25	4 pcs
4956.04	15/7	approx. 0.3	4 pcs



glass miniature "Amuse"

borosilicate glass, transparent, handblown, double-walled

item	Ø / height in cm	content in l	PU
4914	8.5/7.8	approx. 0.19	6 pcs



Please note:



Since all glasses of this series are hand-blown, deviations from the declared content may occur.



glass miniature

borosilicate glass, transparent, handblown, double-walled, with reinforced rim

item	Ø / height in cm	content in l	PU
4901.03	6/7.5	approx. 0.08	6 pcs



glass tumbler

borosilicate glass, transparent, handblown, double-walled

item	Ø / height in cm	content in l	PU
4907	8/10	approx. 0.28	6 pcs



glass miniature

borosilicate glass, transparent, handblown, double-walled

item	Ø / height	content in l	PU
4901.01	6/5	approx. 0.08	6 pcs
4901.02	8.8/7.5	approx. 0.21	6 pcs



small glass bowl

borosilicate glass, inside with satin finish, handblown, double-walled

item	Ø / height in cm	content in l	PU
4963.01	6/8.5	approx. 0.05	6 pcs
4963.02	6.5/9.5	approx. 0.08	6 pcs

Please note:



since all double-walled glasses are hand-blown, deviations from the declared content may occur.

© Copyright 2012 by Fabian Sängler
www.chocolate-culinary.com
Book title: Sweet Inspiration



glass miniature

borosilicate glass, transparent, handblown, double-walled

item	Ø / height in cm	content in l	PU
4903	5.5/8.5	approx. 0.1	6 pcs



small glass bowl "Halfmoon"

borosilicate glass, transparent, hand-blown, double-walled

item	Ø / height in cm	content in l	PU
4954.01	6/7.5	approx. 0.08	6 pcs
4954.02	8/9	approx. 0.17	6 pcs
4954.03	9/9.5	approx. 0.21	6 pcs



small glass bowl "Halfmoon"

borosilicate glass, inside with satin finish, handblown, double-walled

item	Ø / height in cm	content in l	PU
4964	12/7.5	approx. 0.35	6 pcs

The plates made of black china are available on page 227, the etageres "Flex-Tree" on page 250.



glass miniature plate
glass, 4 mm thick, green, structured, leaf shape

item	l x w in cm	PU
5037	14x7,5	12 pcs



small glass bowl
glass, 4 mm thick, structured, dark grey, round, with slight corners

item	Ø in cm	height in cm	PU
5173	8	3	12 pcs



small glass bowl
clear glass, structured

item	l x w in cm	PU
5039	10x8,5	12 pcs



small glass bowl
glass, deep black

item	l x w in cm	PU
5039.01	10x8,5	12 pcs



small glass bowl/spoon rest
glass, 4 mm thick, structured, dark grey, organically shaped, slightly oval form

item	l x w in cm	PU
5172	11x7,5	12 pcs



small glass bowl
clear glass, structured, rectangular, flat

item	l x w x h in cm	PU
5099	11,5x5,5x1,5	12 pcs



glass miniature plate
glass, deep black, flat

item	l x w in cm	PU
5034.01	10x10	12 pcs



bowl/basket "Reef"
pewter, smooth outside, round, food-safe, not dishwasher-safe, with supporting feet, for small glass bowl item 5166 (please order separately)

item	Ø in cm	height in cm
2310	13	8

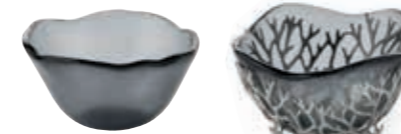

glass bowl
glass, 6 mm thick, dark grey, organically shaped, for bowl/basket "Reef" item 2310 (please order separately)

item	Ø / height in cm	content in l	PU
5166	13/6,5	approx. 0,3	2 pcs

NEW



bowl/basket "Reef"
pewter, smooth outside, round, food-safe, not dishwasher-safe, with supporting feet, for glass bowl item 4814.17 (please order separately)

item	Ø in cm	height in cm
2320	16	5,5



glass bowl
dark grey, round, handblown, ground edge, suitable for bowl/basket "Reef" item 2320 (please order separately)

item	Ø in cm	height in cm	content in l
4814.17	17	5,5	0,3



bowl/basket "Reef"
pewter, smooth outside, round, food-safe, not dishwasher-safe, with supporting feet, for small glass bowl item 4930 (please order separately)

item	Ø / height in cm	PU
2318	8/5	2 pcs



small glass bowl
borosilicate glass, handblown, round for small bowl/basket "Reef" item 2318

item	Ø / height in cm	content in l	PU
4930	7/5	0,14	24 pcs

"Reef" – showpieces of table culture!

More items of the "Reef" series are available as of page 70.



Large numbers of single parts are casted from premium pewter and subsequently assembled in high-grade craftsmanship to give shape to these items. The inimitable pieces of art created that way are unique items, which inspire by the polished surface of the organic structures and the rounded tails of the meshwork.

The products of the "Reef" series are genuine gems of dining culture!

The small presentation baskets can be equipped with various miniatures made of clear or coloured glass and give your food a stunning stage.





The creamer is handmade, deviations from the declared measurements may occur



small glass creamer
clear glass, handblown

item	Ø / height in cm	content in l	PU
5416	4.7/9.8	approx. 0.1	6 pcs



miniature glass bottle

clear glass, round, with glass lid (round), with notched stopper for pouring with closed lid, height incl. lid

item	Ø in cm	height in cm	content in l
5741	4.3	5.5	approx. 0.03



test tube

borosilicate glass (temperature change resistant), with flanged rim and round bottom, for holder for test tube item 4680.S and cork item 1501

item	Ø / height in cm	content in l	PU
4032.G	2/15	0.04	24 pcs

cork

for test tube item 4032.G

item	Ø in cm	length in cm	PU
1501	2/1.7	2.6	24 pcs



The silicone holders for test tubes are also suitable as adjustable feet.



holder for test tubes

silicone, Ø 4.6 cm, 2.7 cm high, with grooves on the inside for easy insertion of glass tubes, for test tube item 4032.G

item	colour	PU
4680.S	black	6 pcs



cork

plastic, ecru, for glass bottles items 5296.01 and 5296.02

Art.-Nr.	Ø in mm	Höhe in mm	VPE
5297.01	2	2,2	24 pcs
5297.02	2,6	2,8	24 pcs



glass bottle

clear glass, square, suitable cork item 5297.01 and 5297.02 (please order separately)

item	l x w x h in cm	content in l	PU
5296.01	3.9x3.9x8.5	0.04	12 pcs
5296.02	4.9x4.9x11	0.1	12 pcs

Its honed sides prevent the glass stopper from falling off when pouring from the closed bottle.



glass bottle/creamer

clear glass, square, with glass stopper (round), with notched stopper for pouring with closed lid, height incl. stopper

item	l x w x h in cm	content in l	PU
5740	5x5x12.5	0.12	3 pcs



small glass bowl

clear glass, square, delivery without lid item 5254.01 (please order separately)

item	l x w x h in cm	content in l	PU
5254	4.9x4.9x4.5	0.05	4 pcs



small glass creamer

clear glass, square, delivery without lid item 5254.01 (please order separately)

item	l x w x h in cm	content in l	PU
5255	4.9x4.9x4.5	0.05	4 pcs



glass miniature

clear glass, lid for small glass bowl item 5254 and glass creamer item 5255

item	l x w in cm	PU
5254.01	4.9x4.9	12 pcs



small butter & lard pot

clear glass, round

item	Ø in cm	height in cm	PU
5424	9	9.5	6 pcs



glass bottle

clear glass, square, with swing top (plastic and stainless steel), height incl. swing top

item	l x w x h in cm	content in l	PU
5295.01	5.4x5.4x12.5	0.1	12 pcs
5295.02	6.7x6.7x14.5	0.2	12 pcs

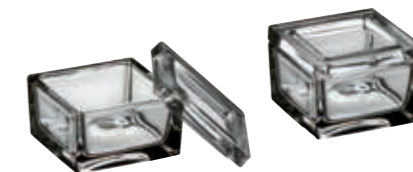

small bowl

clear glass, square, delivery without lid item 5338.01 (please order separately)

item	l x w x h in cm	content in l	PU
5338	7x7x3.9	0.1	12 pcs



glass miniature

clear glass, square, lid for small glass bowl item 5338

item	l x w in cm	PU
5338.01	7x7	12 pcs



glass bottle

clear glass, with swing top (PVC lid), height incl. swing top

item	Ø / height in cm	content in l	PU
5290.01	4.5/14.5	0.1	12 pcs
5290.02	5.5/19	0.2	12 pcs

glass miniature

clear glass, Ø 8 cm, 5 cm high, 0.13 l content

item	version	PU
5420	clear	6 pcs
5420.01	satinized	6 pcs



glass miniature

clear glass, wavy rim, base: 0.07 l content, top part: 0.04 l content, for bridge "Modul" items 4584 and 4724

item	version	Ø / height in cm	PU
5423.01	base	6.5/5.5	12 pcs
5423.02	top	6.3/4.5	12 pcs



glass miniature, 2 parts

glass, satinized, wavy rim

item	Ø / height in cm	content in l (bottom part)	PU
5445	5.5/7.5	approx. 0.05	6 pcs





glass bowl

clear glass, square

item	l x w x h in cm	content in l	PU
5308.08	8x8x4.5	0.14	6 pcs
5308.11	11x11x6	0.3	6 pcs

More sizes of the glass bowl "Unique" are available on page 164.

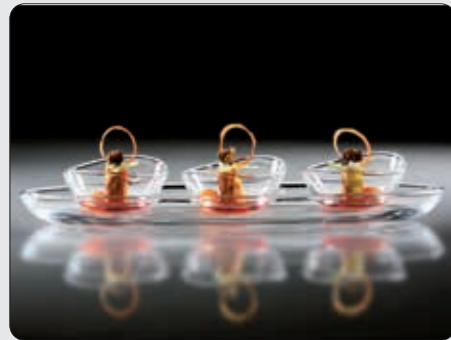

glass bowl

clear glass, oval

item	Ø / height in cm	content in l	PU
5330.08	7.5/3.5	0.08	6 pcs



glass bowl "Unique"

glass, white marbled, outside sated, round

item	Ø / height in cm	PU
5180.10	10/6	6 pcs



coaster/glass insert

clear glass, 4 mm thick, round, edge polished and deburred, with 4 transparent silicone feet, for coaster "Solid" item 4700

item	Ø in cm	PU
5244.11	11	6 pcs
5244	13	6 pcs



glass bowl

borosilicate glass, flat

item	Ø / height in cm	content in l	PU
4910	10.5/2.5	0.18	12 pcs



The melamine tray item 4590 is available on page 268.



glass

clear glass

item	Ø / height in cm	content in l	PU
5380	7.5/10.5	0.32	6 pcs
5381	7.5/6	0.18	6 pcs

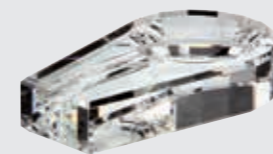

ashtray for cigars

optical glass, transparent, also usable as a rest for tongs or spoons, in black gift box

item	l x w x h in cm	PU
5210	15x9x3	6 pcs



More sizes of the glass bowls are available on page 83



glass bowl

dark grey, round, handblown, ground edge, for ring "SelectionA." item 4681.S (please order separately)

item	Ø in cm	height in cm	content in l
4814.17	17	5.5	0.3



glass miniature

clear glass, for bridges "Modul" items 4584 and 4724

item	Ø / height in cm	content in l	PU
5257	7/10	0.08	12 pcs

glass miniature

clear glass, for bridges "Modul" items 4584 and 4724

item	Ø / height in cm	content in l	PU
5405	5/8.6	0.1	6 pcs

glass bowl/cloche

clear glass, handblown, for ring "SelectionA." item 4681...(please order separately)

item	Ø / height in cm	content in l	PU
5418	9/6	0.2	6 pcs

5444 + 4593 (page 268/269)



glass bowl

clear glass, oval

item	l x w x h in cm	content in l	PU
5444	12.5x7x4	0.08	6 pcs

small glass bowl

borosilicate glass, handblown, round

item	Ø / height in cm	content in l	PU
4930	7/5	approx. 0.14	24 pcs



glass bowl "Duo"

clear glass

item	l x w x h in cm	content in l	PU
5441	11.5x7x3.5	0.07	6 pcs

ring "SelectionA."

silicone, Ø 8.3 cm, for anti-slip placement of bowls item 5418, 4814.17 and 4930

item	colour	PU
4681.S	black	6 pcs

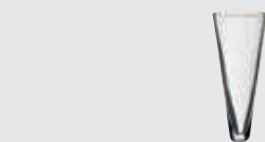

glass cone

clear glass, for food display items 2194...

item	Ø / height in cm	content in l	PU
5415	3.5/8	0.03	12 pcs



Also suitable for tealights.

glass tray

clear glass, 4 deepenings (Ø 4.6 cm), for inserts and portion jam up to Ø 4.4 cm (e. g. Darbo portion jam, 28 g and 40 g)

item	l x w x h in cm	PU
5428.04	23.5x6.2x3	6 pcs



4081.12 + 4593
(page 268/269)



bowl

china, white, oval

item	l x w x h in cm	content in l	PU
4081.12	12.5x7.5x4	0.1	12 pcs

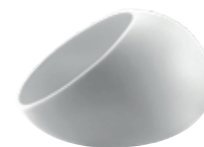

bowl "Cave"

biscuit china, white, inside glazed, opening: Ø approx. 8 cm, in black gift box

item	Ø in cm	height in cm	PU
4375.01PB	approx. 11	7	1 pc



Design: Wilma Greim

"Cave"



glass pillow "Donna"

glass, satined, in black gift box

item	l x w x h in cm
5446.01PB	16.5x11x3

plateau plate "DressCoat"

china, white, useable area (plateau): Ø 7.5 cm, also useable as a bowl

item	Ø / height in cm	content in l	PU
4386.01	9/4.5	0.1	12 pcs

small creamer

china, white

item	l x w x h in cm	content in l	PU
4093	8.2x5.8x4.2	0.07	12 pcs

More items made of melamine are available as of page 130.



bowl/box

melamine, black, surface matt, food-safe, dishwasher-safe, not suitable for microwave and combi steam oven

item	l x w x h in cm	content in l	PU
4598.09	9x6.3x4.5	0.25	6 pcs
4598.13	12.8x9x4.5	0.35	4 pcs



bowl/box

melamine, black, surface matt, food-safe, dishwasher-safe, not suitable for microwave and combi steam oven

item	l x w x h in cm	content in l	PU
4599.13	12.8x12.8x4.5	0.51	4 pcs



cooling pack

nylon, black/white, non-toxic cooling gel

item	l x w in cm
5663.20	20x20



The glass bowls "Cave" are available on page 82.



Stay cool!

Serving chilled food is primarily a technical challenge with certain dishes or intermediate courses. With Zieher's two-coloured cooling pads, this necessity can be met in a sophisticated way, also in terms of visual appearance. The wrapper made of black resp. white nylon fabric appears classy and unobtrusive. The pads are filled with gel which remains shapeable, even when frozen and thus allows an adjustment to the tableware used. The pads can also be used on the buffet. For further information, please have a look at pages 44 and 45.



miniature

china, stackable, Ø 5.3 cm, 7 cm high, 0.1 l content

item	colour	PU
4490	white	6 pcs
4490.01	black, matt	6 pcs



small bowl "Catering"

china, white

item	Ø / height in cm	content in l	PU
4499	8/5.5	0.2	6 pcs



small bowl

china, white

item	Ø / height in cm	content in l	PU
4498	8/6	0.17	6 pcs



small bowl

china, white, square

item	l x w x h in cm	content in l	PU
3844	4x4x3	0.03	24 pcs



small bowl

china, white, square

item	l x w x h in cm	content in l	PU
3853	7x7x2	0.05	12 pcs



small bowl

china, white, square

item	l x w x h in cm	content in l	PU
3859	6.5x6.5x2	0.03	12 pcs



The cruet stands made of stainless steel is available on page 259.



The cruet stands made of stainless steel are available page 262.



small creamer

china, white, square

item	l x w x h in cm	content in l	PU
3849	4.9x4.9x4.5	0.05	4 pcs



small bowl

china, square

item	l x w x h in cm	content in l	PU
3854	7x7x4.5	0.13	4 pcs



small bowl

china, square, 4.9 cm long, 4.9 cm wide, 7 cm high, 0.11 l content

item	colour	PU
3855	white	4 pcs
3855.01	black, matt	4 pcs



small bowl

china, square, 4.9 cm long, 4.9 cm wide, 4.5 cm high, 0.05 l content

item	colour	PU
3845	white	4 pcs
3845.01	black, matt	4 pcs



miniature plate

china, round, flat, Ø 10.5 cm

item	colour	PU
4606.10	white, glossy	12 pcs
4607.10	black, matt	12 pcs



plate

china, round, flat, Ø 17 cm

item	colour	PU
4606.17	white, glossy	4 pcs
4607.17	black, matt	4 pcs



bowl "Modul"

china, white, square, deep, for base trays "Modul" made of walnut and melamine

item	l x w in cm	content in l	PU
4381	11x11	0.07	12 pcs

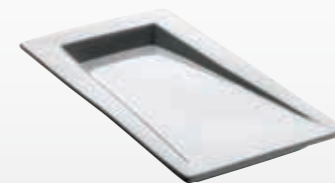

plate "Modul"

china, white, rectangular, flat, for base trays "Modul" made of walnut and melamine

item	l x w in cm	PU
4383	22x11	12 pcs

Suitable etageres are available on pages 254 and 255.



The whole "Modul" series is available on pages 131 to 139





tray

stainless steel 18/10, polished, for e.g. Darbo portion jam (28 g and 40 g), portion ketchup or mustard

item	version	l x w in cm
2191.03	3 holes (Ø 4.5 cm)	19.5x7.5
2191.04	4 holes (Ø 4.5 cm)	24x7.5



amuse gueule/tapas spoon
china, white

item	l x w x h in cm	PU
4260.01	13x4x3	12 pcs

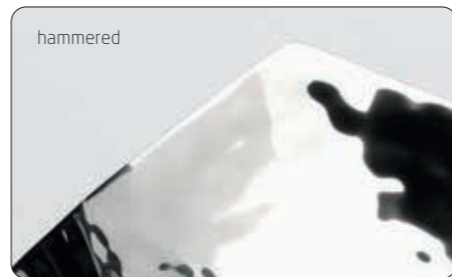

More sizes of the triangular bowls are available on page 91.



bowl

massive stainless steel 18/10, triangular, hammered finish, six times polished

item	Ø in cm	height in cm	content in l
2180.09	9	4	0.08
2180.13	13	6	0.28



etagere

massive stainless steel 18/10, triangular, smooth finish, six times polished, not demountable

item	Ø in cm	height in cm
2187	13	16.5

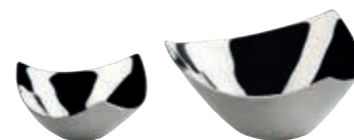

bowl

massive stainless steel 18/10, triangular, smooth finish, six times polished

item	Ø in cm	height in cm	content in l
2182.09	9	4	0.08
2182.13	13	6	0.28



More sizes of the triangular bowls are available on page 91.



Suitable spoon rests made of melamine and walnut are available on pages 134 and 136.



The skewer plate made of slate is available on page 231.



hammered

small skewer "Flame"
stainless steel 18/0, matt

item	length in cm	PU
1939.04	9.5	24 pcs



More "Artisan" items are available on page 84 and 85.

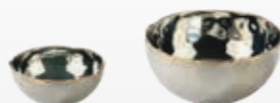

bowl "Artisan"

stainless steel 18/10, inside polished, outside matt finish, round, hammered rim with golden adornment (brass)

item	Ø in cm	height in cm	content in l
2371.07	7.5	3.5	approx. 0.1
2371.11	11	5.5	approx. 0.3



party spoon

stainless steel 18/10, 4.3 mm thick, heavy quality, 21 cm long

item	version
1938	polished
1938.01	hammered

skewer

stainless steel 18/10, polished, 24 cm long

item	version	PU
1939.01	Moon	12 pcs
1939.02	Flame	12 pcs



amuse gueule stand with foot

massive stainless steel 18/10, polished

item	l x w x h in cm
2204.08	11.5x9.5x8.5
2204.11	11.5x9.5x11.5



ice cream cup with foot

massive stainless steel 18/10, hammered, polished

item	l x w x h in cm	content in l
2207.11	11.5x10x11	0.15
2207.15	13.5x11x15	0.25



Suitable etageres are available on page 99.



Plateau plates



Design: Itamar Harari

Please note:

The placement of plateaus of the same height next to each other is only possible to a limited extent.



The coil shape holders and suitable inserts are available on page 100.



miniature plate with rod

massive stainless steel 18/10, hammered, polished, plate approx. 9x8 cm, for marble platters 8052 and 8054

item	height in cm
2203.08	8
2203.13	13
2203.18	18
2203.23	23



marble platter

black/brown, polished surface, sides rough-textured, stainless steel feet, 24 holes (Ø 5 mm), for holder coil shape items 2167... or skewer items 1939... or miniature plates items 2203... (please order separately)

item	l x w x h in cm
8052	45x31x5

NEW



plate, slate

natural slate, rectangular, with 3 holes (Ø 5 mm), with 4 feet of felt (not dishwasher-safe), for holder coil shape items 2167... or skewer item 1939... or miniature plates items 2203... (please order separately)

item	l x w x h in cm
8054	30x10x2.5



Skewers



and more!



Slate is a unique and exceptional natural product. The surfaces of our slate plates have the typical slaty cleavages, therefore every piece is unique. Small deviations in structure, thickness and weight of the plates cannot be avoided because of the nature of the product. There may be single inclusions of other minerals and fossils. These extraordinary features give slate its precious and vivid appearance. Please note: Specific groceries, especially those that contain fruit acid (citric acid), may damage the surface in case of longer contact. Therefore we recommend avoiding direct contact with edibles.

Marble is a natural product, which means that the dark brown marbling can vary strongly. This is exactly what creates the vivid and unique look of this natural stone. Please note: Specific groceries, especially those that contain fruit acid (citric acid), may damage the surface in case of longer contact. Therefore we recommend avoiding direct contact with edibles. Please clean only with a wet cloth and gentle cleaners. Not dishwasher-safe. Cleaning in a dishwasher may dull the surface.

small skewer "Flame"

stainless steel 18/0, matt

item	length in cm	PU
1939.04	9.5	24 pcs

*Drilled holes Ø 3 mm:
suitable for items 1939.04 or
usual skewers made of wood



skewer plate, slate

natural slate, not sealed, rectangular, double, with 35 holes (Ø 3 mm*), with 6 feet of felt (not dishwasher-safe)

item	l x w x h in cm
8051	35x25x2.6

skewer

stainless steel 18/10, polished, 24 cm long

item	version	PU
1939.01	Moon	12 pcs
1939.02	Flame	12 pcs



8052 + 2203...

35 years of ZIEHER – a story of success from 1986 to 2021



Starting years as trading company

1986 – 1996

In 1986 Manfred Zieher and his wife Christa founded the company. Traditional gastronomic items were offered under the name MAC and soon also presented in an own catalogue and on shows. In 1994 the company was finally named Zieher.



Wine and more

Since 2015

The cornerstone for a collection for ambitious wine lovers was laid in 2015 with the "Vision" series. These unique wine glasses have been developed together with sommelier Silvio Nitzsche from Wein | Kultur | Bar Dresden. In 2017 the range has been extended by the extraordinary decanters "Eddy" and "Star" and has been made accessible through specialised retailers also for end users.



Establishment as gastronomic partner

1997 – 2005

In the second decade, Zieher became established as partner of gastronomy specialised shops. Since 1996 the company is located in Himmelkron, the prominent brand logo was registered in 2004 as a word and figurative mark.

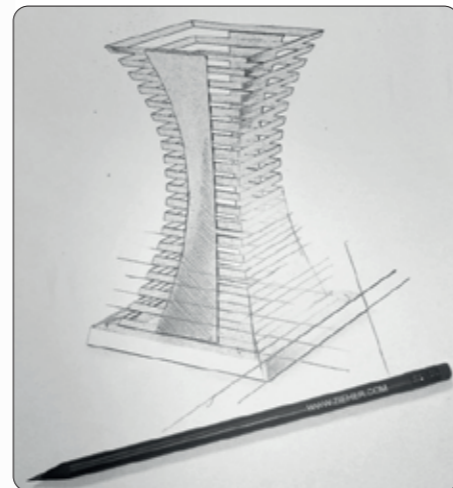

Focusing and generational change

Since 2020

Zieher is focussing on their skills and positioning themselves more and more as an extravagant design manufacturer for luxury food presentation and wine glasses. The professional range has been tightened and the range for end users has been reduced to the FOR WINE LOVERS range. In 2021 the generational change has been carried out and the company has been handed over to the children Dominik Zieher, Jennifer Hübsch and Oliver Zieher (ltr).



Zieher today

In 2022 Zieher is present in 5 * Hotels and top restaurants in more than 90 countries and appreciates the long lasting, often amicable relationship with clients, partners and suppliers. As partners from the very beginning, a very special thanks

to Thomas Dötzer from Dötzer Restauration Bayreuth for his extraordinary culinary expertise and to Photographer Gerd Preiss for the artful composition and the exclusive styling of the Zieher image library.



Extravagance designed by Zieher

Since 2006

The first Zieher designed products were released in 2006. Individual creations in the luxury segment emerged from the close cooperation with renowned chefs and the inspiration by their artistry. Besides the cooperation with well-known Designers such as Itamar Harari for instance, many products bear the signature of Oliver Zieher. In 2009, "Skyline" - a benchmark for extremely flexible buffet systems - has been developed.



Silvio Nitzsche



Gerd Preiß

Thomas Dötzer

WWW.ZIEHER.COM



21, Markarian Building, Street 401, Mkalles
T: +961 1 694 194 M: +961 76 444 660
P.O.Box 55240 Sin El Fil, Lebanon
E-mail sales@mghotelsupplies.com
f MG SUPPLIES @ MG.SUPPLIES